

# TOYOTA

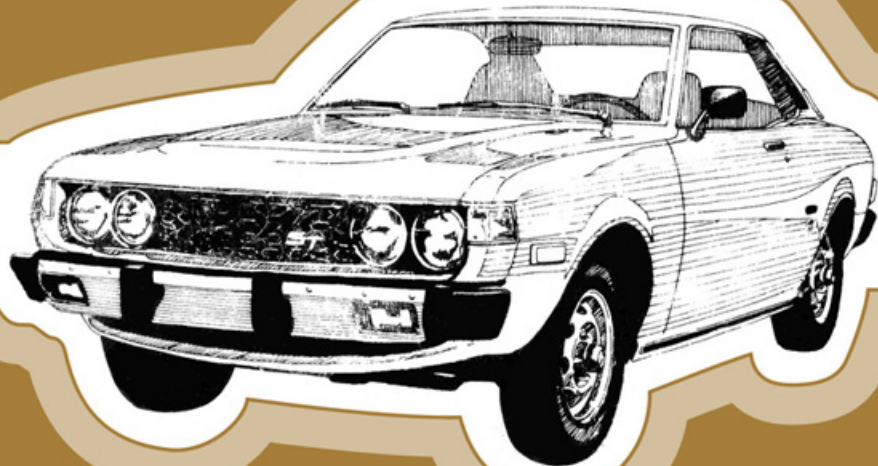

## **Celica**

**1977  
Owner's  
Manual**

## **Your Toyota's 1000 Mile Maintenance is *FREE!***

The scheduled maintenance at 1,000 miles is vital. It's so important, in fact, that we will do it **FREE OF CHARGE**. That's right. Any Toyota dealer will perform this entire maintenance at no cost to you. And the maintenance is no small thing. Here's the full list of what the dealer will do:

- Adjust valve clearance
- Inspect and adjust engine drive belts
- Tighten engine bolts
- Adjust engine idle speed
- Inspect dwell angle and ignition timing
- Inspect brake and clutch fluid levels
- Tighten bolts and nuts on chassis and body

Please note: If you ask to have any other lubrication or maintenance work done, the dealer will charge you for it.

Regular maintenance is essential. We urge you to protect your new car investment by having your Toyota serviced according to the maintenance schedule given in Section 5 of this book.

Toyota warrants that the emission control systems in its vehicles are designed and built to conform with the strict standards established by the Clean Air Act (USA). Providing that the owner observes the maintenance requirements specified by the vehicle manufacturer, the emission control systems are warranted as described in the separate warranty statement.

# TOYOTA



## Celica

### 1977 Owner's Manual

#### Maintenance Operation

All information and specifications in this manual are current at the time of printing. However, because of Toyota's policy of continual product improvements, we reserve the right to make changes at any time without notice. Please note that this manual applies to all Celica models and explains all equipment, including options. Therefore, you may find some explanations for equipment not installed on your car.

© 1977 TOYOTA MOTOR SALES CO., LTD.  
All rights reserved. This material may not be reproduced  
or copied, in whole or in part, without the written  
permission of Toyota Motor Sales Co., Ltd.

**NOTE:** This owner's manual is for all Celica models sold in the U.S.A., Canada, American Samoa, Guam, and Puerto Rico. Therefore, you may find information included in it that does not apply to your car. The following designations will tell you which information applies only to specific models:

**Calif.** — For cars sold in California only.

**Canada** — For cars sold in Canada only.

**Hi-alt.** — For cars sold in high-altitude areas (over 4000 ft) of the U.S.A. only.

You can tell if your car is a "high-altitude" model by referring to the Vehicle Emission Control Information label on the underside of the engine hood.

# foreword

Welcome to the growing group of value-conscious people who drive Toyotas. We are proud of the advanced engineering and quality construction of each vehicle we build.

We invite you to read through this Owner's Manual. It is designed to acquaint you with the features of your new Toyota and to help you enjoy many miles of motoring pleasure.

When it comes to service, remember that your Toyota dealer knows your vehicle best and is interested in your complete satisfaction. He'll provide quality maintenance and any other assistance you may require.

Toyota Motor Sales Co., Ltd.

# table of contents

Section	Page
1 Information for the new owner .....	1
2 Driving tips .....	23
3 In case of an emergency .....	29
4 Appearance care .....	37
5 Maintenance requirements .....	39
6 Do-it-yourself maintenance .....	47
7 Consumer information .....	65
8 Specifications .....	69
9 Index .....	73

# information for the new owner—section 1

## An important warning about the catalytic converter

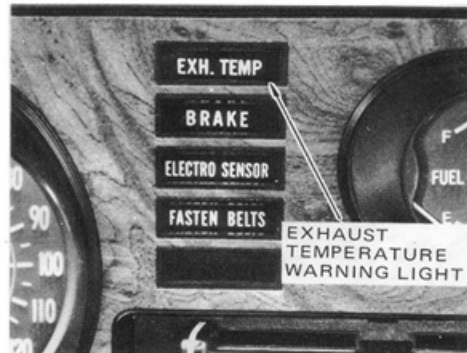

If your car has an "Exhaust Temperature" warning light, it is equipped with a catalytic converter in the exhaust system.

The catalytic converter is an emission-control device installed in the exhaust system. It looks somewhat like a muffler, but it performs an important job in maintaining cleaner air.

*If a large amount of unburned gasoline flows into the converter, it may overheat and create a fire hazard.* To prevent this, observe the following precautions:

- Do not drive with an extremely low fuel level. This may cause engine misfire which creates an extra load for the converter.

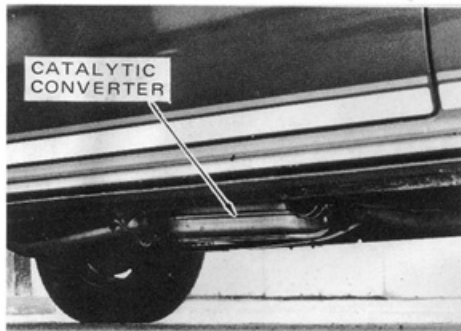

- Do not allow the engine to run at fast idle speed for more than 10 minutes or at normal idle speed for more than 20 minutes.
- Do not use only engine braking on long down grades.
- Do not turn off the ignition while the car is moving.
- Do not modify or tamper with any part of the engine or emission control system. All inspections and adjustments require a qualified technician.

*If the catalytic converter should begin to overheat, the "EXH. TEMP" warning light on the dashboard will come on.* See page 12 for what to do.

## Gasoline recommendation

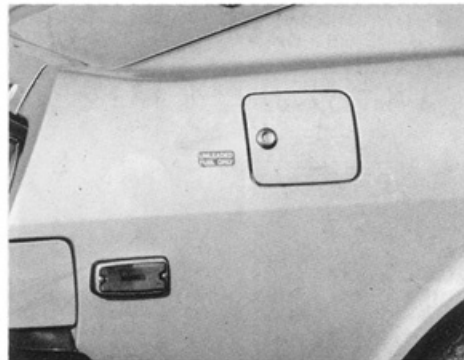

**For cars sold in the U.S.A., you must use only UNLEADED FUEL.**

To help prevent gas station mixups, all Celicas sold in U.S.A. have a new smaller gas tank opening. The special nozzle on pumps with unleaded gas will fit it, but the larger standard nozzle on pumps with leaded gas will not fit.

**For cars sold in Canada, we recommend UNLEADED FUEL. Using unleaded fuel will prolong engine and spark plug life.**

If unleaded fuel is not available, you may use any regular gasoline if the octane rating (research octane No.) is 90 or higher.

## Gasoline recommendation (cont.)

**Gasoline tank capacity:**  
15.3 gal (12.8 Imp. gal., 58 liters)

**Before driving your Toyota outside of the United States or Canada, make sure that the correct gasoline will be available.**

Unleaded gasoline is not commonly available in other countries. Also, the gasoline in other countries may not have a high enough octane rating.

If you plan to register your Toyota in another country, first make sure that it meets that country's regulations.

## Tips for driving the first 1000 miles

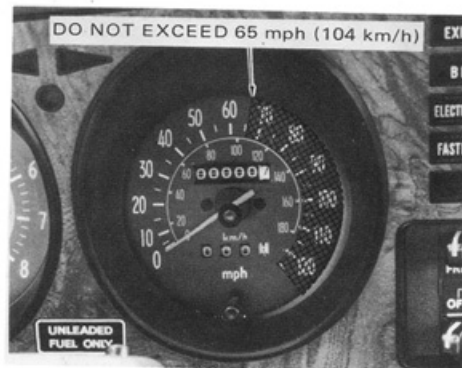

### Drive gently and avoid high speeds.

You need not follow a "break-in" schedule with your new Toyota. But following a few simple tips for the first 1000 miles can add to the future economy and long life of your car:

- Do not drive over 65 mph (104 km/h).
- Maintain engine speed between 2000 and 4500 rpm.
- Avoid full-throttle starts.
- If possible, avoid hard stops during the first 200 miles.
- Do not drive slowly with the transmission in a high gear.

- Do not drive for a long time at any single speed, either fast or slow.

Your new engine is tight and it runs on a very lean gasoline mixture for emission control. *As a result, it may be slightly difficult to start or it may not idle smoothly.* After several thousand miles, the engine will be broken in and these problems should disappear. If not, any Toyota dealer will gladly make the minor adjustments needed.



## Two keys for your car

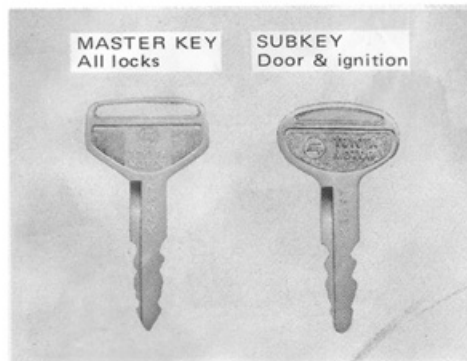

The master key works in every lock. The subkey will not work in the trunk or glovebox.

To protect things locked in the trunk or glove box when you have your car parked, leave the subkey with the attendant. Since the doors and trunk can be locked without a key, you should always carry a spare master key in case you accidentally lock your keys inside the car or trunk.

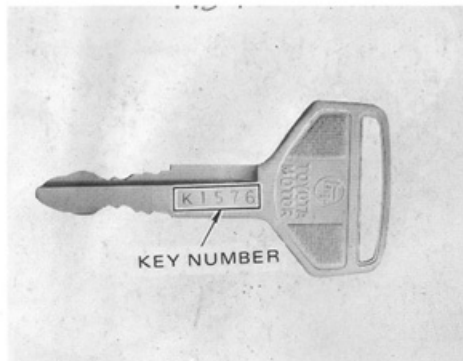

Copy down the master key number and keep it in a safe place.

If you should ever lose your keys or if you need additional keys, duplicates should be made by a Toyota dealer using the key code number. It's a good idea to write the number on a card you keep in your wallet, such as your driver's license. You should also put a copy of the key number with your important papers.

## Door locks

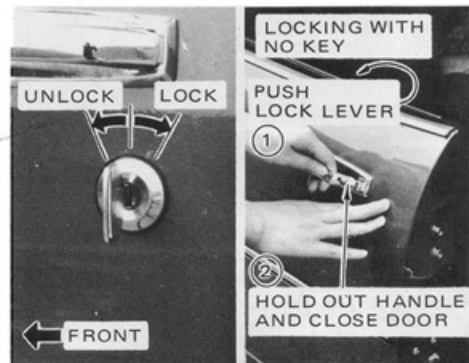

To lock and unlock doors from the outside....

You can, of course, use your key. Turn the key towards the *back* of the car to lock and towards the *front* to unlock.

To lock the doors without a key, push in the lock lever. Then hold the handle out as you close the door. *Be careful not to lock your keys in the car.*

## Door locks (cont.)



To lock and unlock doors from the inside....

After closing the door, just push in the lock lever. The door then cannot be opened with either the outside or the inside door handle. *We recommend locking the doors while driving, especially when small children are in the car.*

## How to adjust the front seats

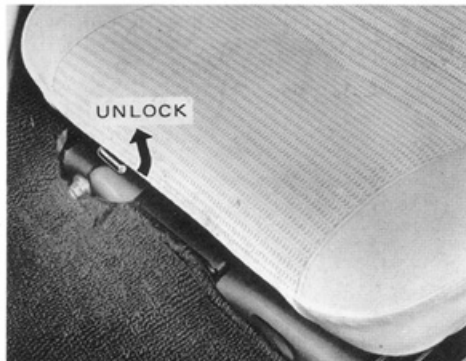

To move the seat forwards or backwards, pull the lock lever up. Then slide the seat to the desired position and release the lever.

*These adjustments should not be made when the car is moving.*



To change the seatback angle, lean forward and pull the lock lever forward. Then lean back to the desired angle and release the lever.

If desired, the seatbacks may be fully reclined. The seatback will return to the upright position when the lever is pulled forward and no weight is on it.

## Easy rear-seat entry

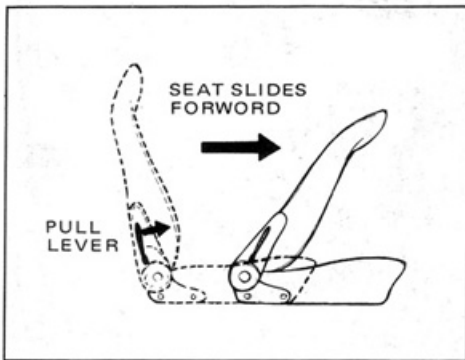

Pull the seatback lever forward—the passenger's seat will automatically slide forward.

After your passengers are in, simply slide the seat rearward. It will lock into place. Readjust it forwards or backwards for the most comfortable leg room.

## Fold-down rear seat (liftback)



Unlock the seatback, and fold it down.

Hold the lock release levers until you've swung the seat back forward a bit.

## Luggage cover (liftback GT)



A roll-up cover is provided for the luggage area. Simply pull it out of the rear seat back and snap it to either the inside of the rear hatch or the body below the hatch.

## The front seat belts



To put on a belt, pull it out of the retractor and insert the tab into the buckle.

You'll hear a "click" when the tab locks into the buckle. Make sure that the belt is not twisted.

The front seat belt length automatically adjusts to your size and the seat position.

The retractors will lock the belt only during a fast stop or on impact. At other times you can move around freely.



Adjust the position of the lap and shoulder belts.

The lap belt should be *as low as possible on your hips*—not on your waist.



Adjust the comfort clip to provide a little slack in the shoulder belt.

This prevents any possible discomfort from the tension of the belt-return spring. To adjust the clip, pull the belt down a little and then push the clip up against the seat belt guide to hold the slack. *Do not put more than 3 inches (75 mm) of slack between the belt and your chest (the width of a fist).* Too much slack will keep the belt from protecting you in an accident.



To release a belt, press the buckle-release button and allow the belt to retract.

If the belt doesn't fully retract, pull it out and check for kinks or twisting. Then make sure that it remains untwisted as it retracts.

## The rear seat belts

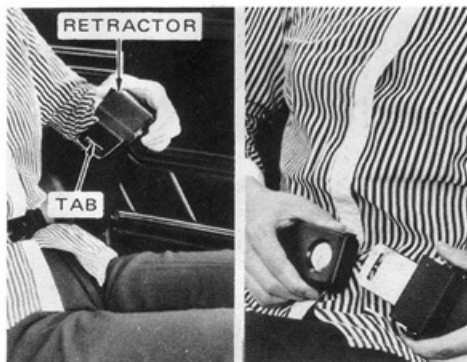

The rear seat belt length may be adjusted at the retractor, and the belt buckle fastens just like the front.

To lengthen the belt, hold the retractor unit at a right angle and pull out the belt.

You should hear a "click" when you push the tab into the buckle. Make sure the belt is not twisted, or it may not retract smoothly. To release the belt, press the buckle button.

## Seat belt tips

- **Small person or youth in front seat.** Move the seat fully forward and raise the seat back to its most upright position.
- **Pregnant woman or injured person.** Wearing a seat belt may be dangerous. Ask your doctor for specific recommendations.
- **Babies and small children.** Special safety seats are available. We recommend their use.
- **Inspect the belt system periodically.** Check for cuts, frays, and loose parts. Damaged parts should be replaced. Do not disassemble or modify the system.
- **Keep the belts clean.** If they need cleaning, use a mild soap solution. Never use bleach, dye, or abrasive cleaners—they may severely weaken the belts.
- **Replace the belt assembly if it has been used in a severe impact.** The entire assembly should be replaced even if damage is not obvious.
- *Always have the driver and all passengers fasten their seat belts whenever the car is moving.*

## Overview of the instruments and controls

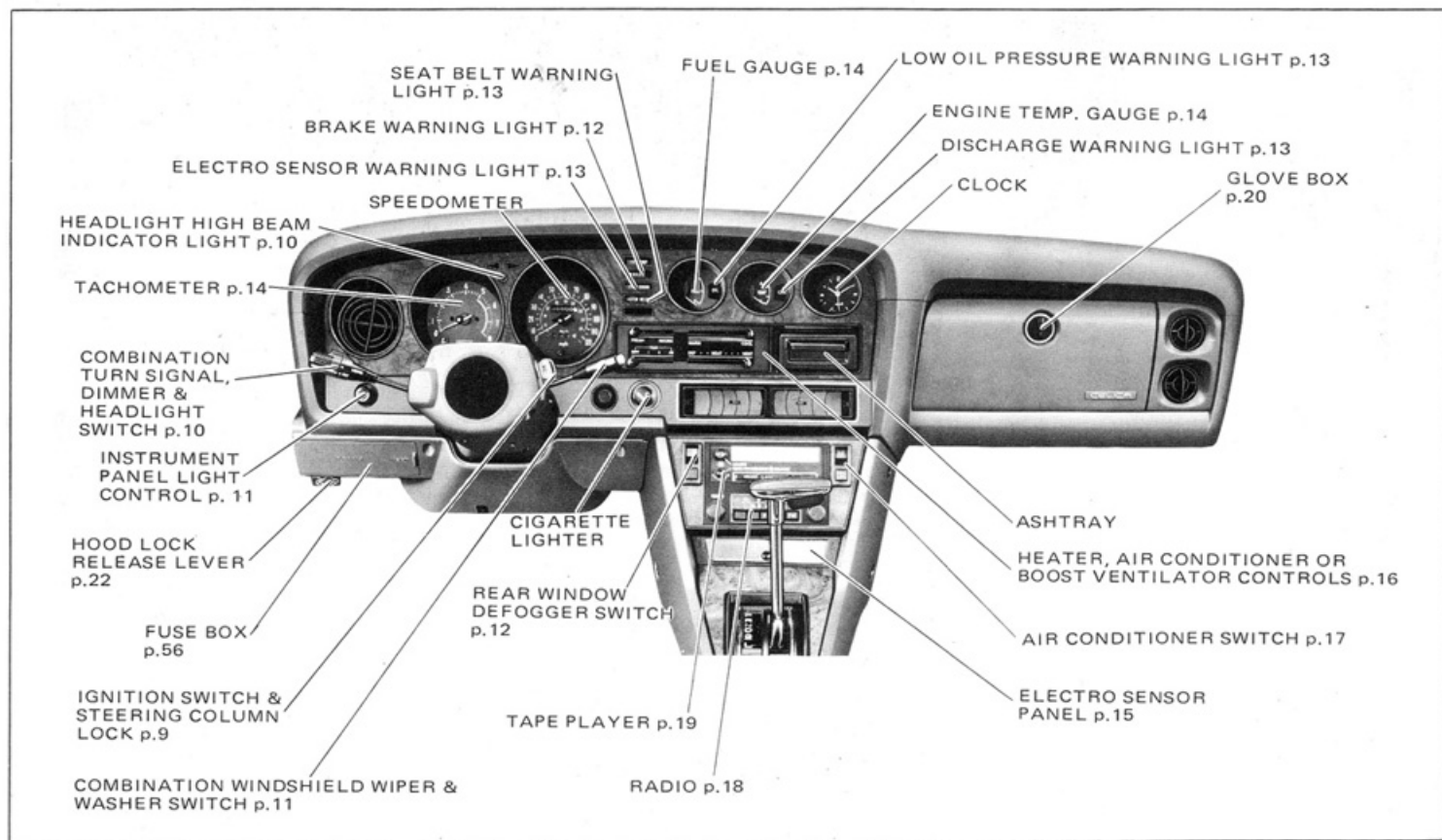

## Combination ignition switch and steering lock

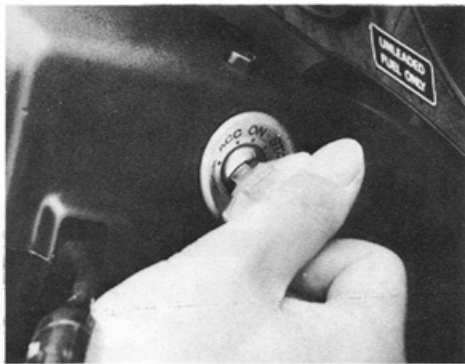

**START**—Starter motor on.

Before starting, make sure that an automatic transmission is in park or neutral, or a manual transmission is in neutral with the clutch pedal depressed. As soon as the engine starts, release the key. It will return to the ON position. Don't crank the starter continuously for more than 15 seconds. (For starting tips, see page 23.)

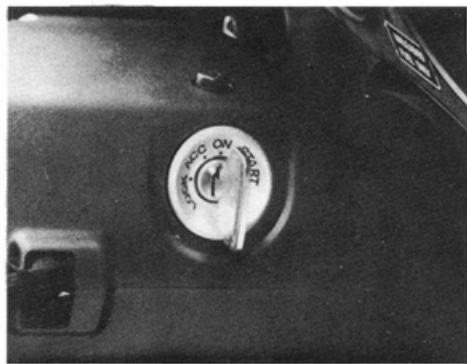

**ON**—Engine on and all accessories on.

This is the normal driving position. *Do not leave the key in the ON position if the engine is not running.* The battery will discharge and the ignition could be damaged.

**ACC**—Accessories such as the radio operate, but the engine is off.

If you leave the key in the ACC or LOCK position and open the driver's door, a buzzer will remind you to remove the key.

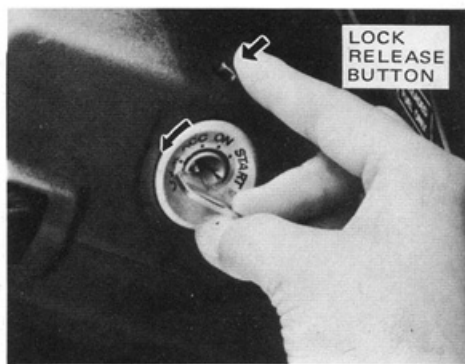

**LOCK**—The steering wheel is locked. The key can be removed only at this position.

You must press in the lock release button to turn the key from ON or ACC to the LOCK position. When starting the engine, the key may seem stuck at the LOCK position. To free it, just rock the steering wheel slightly while turning the key gently.

**Never turn the key to LOCK when the car is moving.** If you must turn the engine off, switch to ACC but do not press the lock release button. Do not push, tow, or coast your car with the key at LOCK.

## Combination headlight, dimmer, and turn signal switch



To turn the lights on, twist the knob on the end of the switch.



For high beams, push the switch forward. Pull back for low beams. For headlight flasher, pull further back.

A purple light on the dashboard indicates high beams.

The flasher works even when the headlights are off.

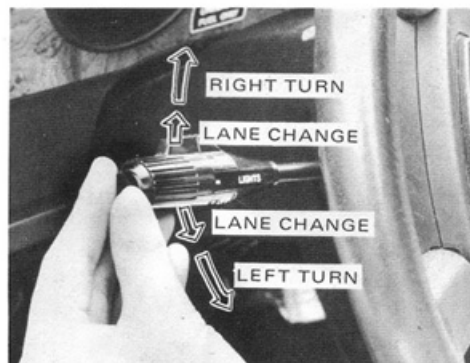

For signaling turns, move the switch up or down in the conventional manner.

The turn signal is self-cancelling after a turn. But after a lane change, you may have to cancel it by hand. You can also signal a lane change by moving the turn signal lever part way and holding it there. If the green dashboard light comes on but does not flash, it indicates that the front or rear turn signal bulb has burned out. If the dashboard light does not come on, the fuse or the indicator light itself has probably failed. You may change headlight beams even when the turn signal is on.



## Windshield wiper and washer switch

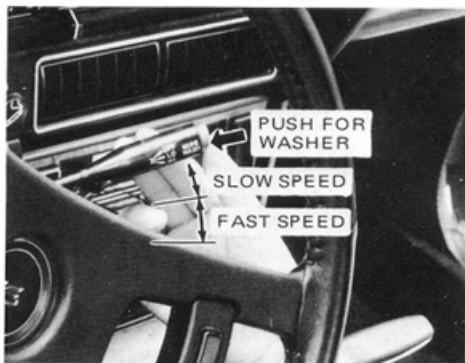

To turn the wipers on, pull the switch down.

To make the washers squirt, push the button on the end of the switch.

Don't run the wipers if the windshield is dry. It may scratch the glass.

If the washer doesn't work, check the amount of fluid in the tank under the hood.

In cold weather, warm the windshield with the defroster before using the washer. This will help prevent icing, which would block your vision.

## Emergency flasher switch

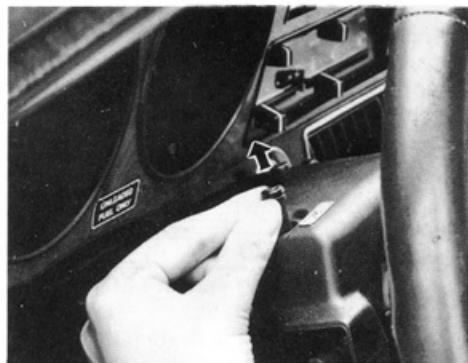

To turn on the emergency warning lights, pull the knob up.

All four turn signal lights will flash. The engine can be on or off. You don't even need an ignition key.

Turn on the emergency flashers to warn other drivers if your car must be stopped where it might be a traffic hazard.

*Always pull as far off the road as possible.*  
(For emergency information, see page 29.)

## Instrument panel light control

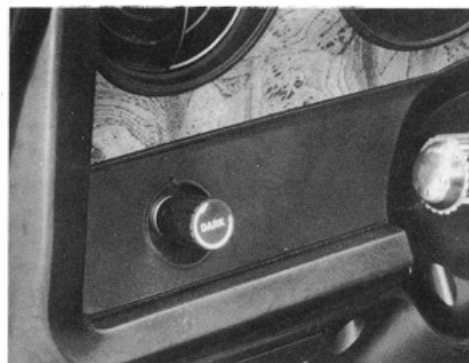

Turn the knob clockwise to dim the instrument panel lights.

## Rear window defogger



To turn on the electric defogger, push the switch with the engine running. Another push will turn it off.

The thin heater wires on the inside of the rear window will quickly clear the glass.

## The warning lights— what to do if one comes on while driving

IF THE LIGHT COMES ON...	DO THIS
1. High exhaust temperature warning (Calif. and Hi-alt.)	Slow down
2. Brake system warning	If parking brake is off stop and check
3. Electro sensor warning	Stop and check console panel
4. Seat belt warning	Fasten seat belts
5. Discharge warning	Stop and check
6. Low oil pressure warning	Stop and check

### 1. High Exhaust Temperature Warning Light (Calif. and Hi-alt. only)

This light indicates that the temperature of the catalytic converter is too high. Fast or hard driving may cause the light to come on. If this light comes on, slow down and, as soon as possible, stop the car in a safe place. *Do not drive continuously with this light on.* When you stop the car, do not park it over dry grass or anything else that might burn easily. Turn off the engine and let the converter cool. If the light does not go out when the converter has cooled, you may drive at moderate speeds to a Toyota dealer or qualified repair shop.

To make sure that this warning light is working, check to see that it lights up

when the ignition key is turned to the START position. If it doesn't, have the bulb and circuit checked.

### 2. Brake System Warning Light

This light has two separate functions:

**Parking Brake Reminder.** If the BRAKE light is on, make sure the parking brake is fully released. The light should go off.

**Brake Fluid Level Warning.** If the BRAKE light remains on even when you fully release the parking brake, or if it comes on when you depress the brake pedal two or three times in succession, the brake fluid level in either the front or rear reservoir is low. Check the fluid level of the see-

through reservoirs. (See page 57 for checking and adding fluid.)

**Continued normal driving is dangerous.** Get the brakes repaired immediately.

### 3. Electro Sensor Warning Light (GT only)

If this light flickers or stays on while you're driving, ***pull off the road immediately*** and check the Electro Sensor Panel on the console to identify the problem. It will continue to warn you until the problem is fixed. (For details, see page 15.)

### 4. Seat Belt Warning Light and Buzzer

As a reminder to you and your passengers, the warning light will come on for about five seconds each time you start the car. The buzzer will operate only if the driver's seat belt is not fastened before starting.

### 5. Discharge Warning Light

This light indicates that the battery is being discharged. If it comes on while you're driving, ***stop and check*** for the cause. Look first at the fan belt. If it's loose or broken, the alternator will not charge the battery properly. (See page 52 for instructions on how to check and adjust the belt.) If the belt is OK, there is a problem somewhere

in the charging system. The engine ignition will continue to operate, however, until the battery is discharged. Turn off the air conditioner, blower, radio, etc., and drive directly to the nearest Toyota dealer or repair station.

***Do not continue driving if the fan belt is broken or loose.*** The engine will overheat.

### 6. Low Oil Pressure Warning Light

This light indicates that the oil pressure is low. If it flickers or stays on while driving, ***pull off the road immediately and stop the engine.*** First check the oil level; it may be low. (Instructions for how to check and add oil are on page 48-50.) If the level was low but adding oil does not cause the light to go out when the engine is restarted, turn it off immediately and call a Toyota dealer for assistance.

***Do not drive the car—even for one block—until the cause is fixed.*** It may ruin the engine.

The light may occasionally flicker when the engine is *idling* or it may come on briefly after a hard stop. There is no cause for concern if it then goes out when the engine is accelerated slightly. However, you should check the oil level at your next opportunity because it may be low.

### **How to check all the dashboard warning lights (except the High Exhaust Temperature Warning Light):**

Turn the key ON, but do not start the engine. All the warning lights on the dashboard should come ON. If one doesn't, the bulb is burned out or the circuit needs fixing. Have it checked as soon as possible.

## Engine temperature gauge

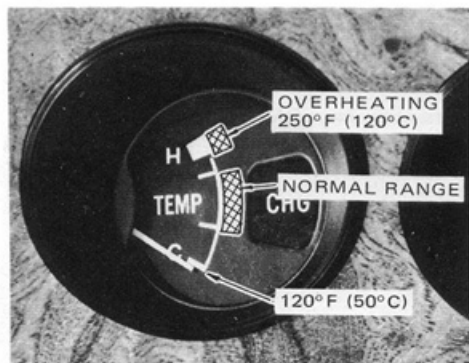

If the needle points to the red zone or higher, stop your car and allow the engine to cool.

The gauge indicates the engine coolant temperature when the ignition switch is ON. The engine operating temperature will vary with changes in weather and engine load. (If your car overheats, see page 31.) *Do not continue driving with an overheated engine.*

## Fuel gauge

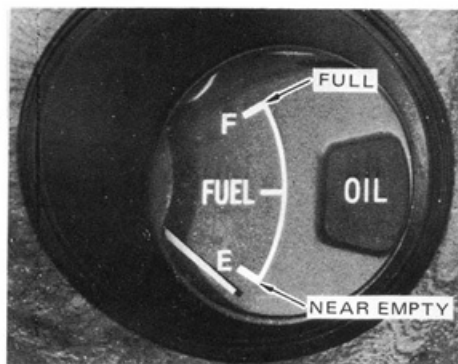

It's a good idea to keep the tank over  $\frac{1}{4}$  full.

The gauge works when the ignition switch is ON. For the most accurate reading, the car should be on level ground and either stopped or at a constant speed.

## Tachometer (ST & GT)



The tachometer indicates engine speed in thousands of rpm (revolution per minute). Use it while driving to select correct shift points and to prevent engine lugging and overrevving.

Driving with the engine running too fast causes excessive engine wear and poor fuel economy. Remember, in most cases the slower the engine speed, the greater the fuel economy. For fast acceleration on level ground, allow the engine to reach 4000 to 4500 rpm before shifting to the next higher gear. *You may rev the engine up to 5500 rpm for short periods of time, but never exceed this rpm. You may cause severe engine damage if you run the needle into the red zone.*

## Electro sensor panel (GT)



The electro sensor panel (ESP) detects eight separate malfunctions:

**ENGINE OIL** – This sign indicates that the engine oil level is low. If it comes on or even flickers while driving, pull off the road immediately. (Instructions for how to check and add oil are on page 48.) *Do not drive for a long time or at high speeds with low engine oil.*

**VAC. BOOSTER** – If this sign comes on when the engine is running, the brake booster has insufficient vacuum. *Be prepared because pedal effort and stopping distance will be increased.* Have the booster system checked and repaired immediately; continued normal driving could be dangerous.

**RADIATOR** – This sign indicates that the coolant level is low. *Driving with low coolant will cause the engine to overheat.* Add water to the reservoir as soon as possible (See page 50 for instructions.)

**BRAKE LIGHTS** – If this sign lights up, one of the stop lights or the fuse has burned out, and should be replaced as soon as possible. (Instructions are given on pages 56 and 63.) If replacing the bulb or fuse does not solve the problem, have the system checked by your Toyota dealer.

**BATTERY** – This sign indicates low fluid level in the battery. *Continuous driving with a low electrolyte level will damage the battery.* Add distilled water as soon as possible. (Instructions for checking the level are on page 55.)

**LINING WEAR** – This sign indicates that it is probably time to replace the front brake pads, well before any decrease in braking effectiveness is noticed. Have the brake system checked at your earliest convenience.

**W. WASHER** – This sign indicates that the windshield washer fluid level is low and should be replenished as soon as convenient.

**TAIL LIGHTS** – This sign detects lights or fuse that have burned out and should be

replaced as soon as possible. (Instructions are given on page 56 and 63.)

- **To make sure that the ESP is working:** Check to see that all the warning messages appear when you press the CHECK button four times with the ignition ON. If one doesn't appear, that system needs fixing. Have it repaired immediately.
- **The ESP is intended only to detect a problem.** It does not tell you when to have maintenance performed. You should always have your car regularly serviced according to the schedule given in Section 5.

## How the heater and vent controls work

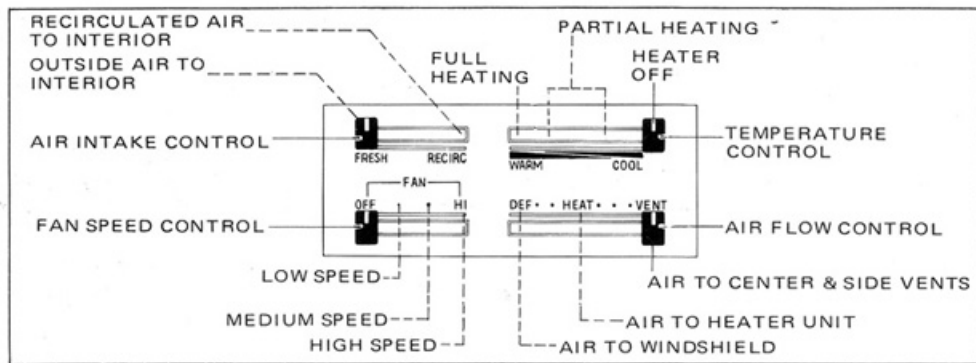

### HEATER and FAN

The purpose of the four controls is simple:

- The **air intake control** is used to select where the air is coming from (recirculated or fresh air from outside).
- The **fan speed control** is used to turn the fan on and to select one of the three fan speeds.
- The **temperature control** is used to turn the heater on and off and to select the amount of heating desired.
- The **air flow control** is used to select where the air is going (to the floor, to the side and center vent louvers, or to the windshield).

### VENTILATION (NO HEAT)

- Move the **air intake lever** to the FRESH position.
- Move the **air flow lever** to the VENT position.
- Move the **temperature level** fully right to the COOL position. This turns off the heater.
- If desired, turn on the **fan** for additional fresh air.

### HEATING

- Move the **air intake lever** to FRESH for **normal** heating, with fresh air passing

through the heater, or to RECIRC for **faster** heating of inside air only.

- Move the **air flow lever** to the HEAT position.
- Adjust the **temperature lever** for the most comfortable setting. The full-left position gives maximum heating.
- Turn on the **fan**. Higher speeds will warm up the car faster.

### DEFROSTING or DEFOGGING

- Move the **air intake lever** to the FRESH position.
- Move the **air flow lever** to DEF. This directs most of the air to the windshield. A portion of the heated air can be directed to the side windows through the side vents by closing the center vent louvers. Adjust the side vent louvers toward the side windows.
- Move the **temperature lever** to the middle or full left. The WARM setting will give the fastest results.
- Set the **fan** on high speed. Once the windshield is cleared, the fan speed and heater temperature may be reduced.

### OPERATING TIP

- In winter, remove any snow blocking the air inlet in front of the windshield.

## How the air conditioner controls work

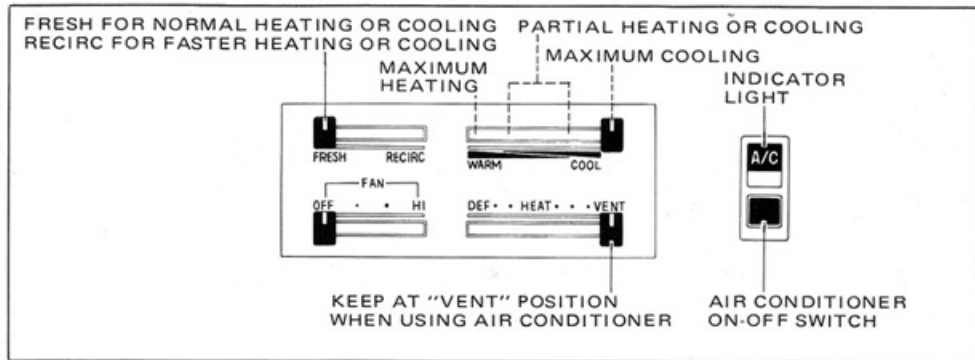

### AIR CONDITIONER (A/C) ON-OFF SWITCH

This is the only visible control added when your Celica is equipped with air conditioning. The switch is used to turn the system on or off by pushing it repeatedly.

### COOLING

- Turn the *air conditioner switch* on. The indicator light shows that the air conditioner is working.
- Move the *air intake lever* to FRESH for *normal* cooling or to RECIRC for *faster* cooling.
- Move the *air flow lever* to the VENT position.

- Adjust the *temperature lever* for the most comfortable setting. The full-right position gives maximum cooling.
- Turn on the *fan*. Medium or high speed works best.

### VENTILATION (NO COOLING), HEATING, DEFROSTING or DEFOGGING

- Turn the *air conditioner switch* off.
- Use all the controls in the same way as described in the Heater Section.
- If the *air intake lever* is moved to RECIRC and the *air conditioner switch* is on, the system will work as dehumidified heating.

### AIR CONDITIONING TIPS

- After parking in the hot sun, drive for the first few minutes with the windows open. After the excess heat has blown away, roll up the windows to keep out hot air.
- When selecting a colder setting, also speed up the fan to medium or high. In humid weather especially, the additional air flow is necessary to prevent frost from forming on the cooling unit. If the unit should begin to frost over, you'll notice it because cooling efficiency will drop. To remove the frost, turn the air conditioner switch off and run the fan at high speed.
- On long uphill drives, the additional load of the air conditioner may cause engine overheating. Watch the engine temperature gauge carefully. If the needle approaches the red zone, turn the air conditioner switch off.
- When not in regular use, turn the air conditioner on for more than 5 minutes once a week. This will keep the compressor and seals lubricated.

## Boost ventilator

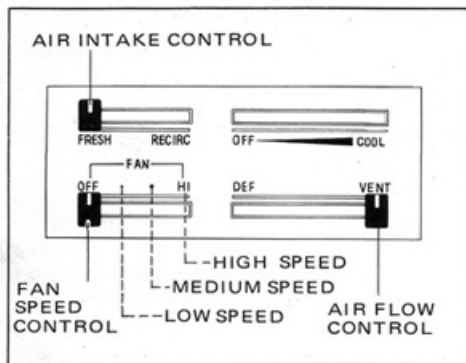

Move the air flow lever to VENT, the air intake lever to FRESH and the fan speed control to select one of three speeds.

Move the air flow lever to DEF. This directs most of the air to the windshield. A portion of the air can be directed to the side windows through the side vents by closing the center vent louvers. Adjust the side vent louvers toward the side windows. To stop ventilating, move the air flow lever to RECIRC and turn off the fan.

## How the radio works

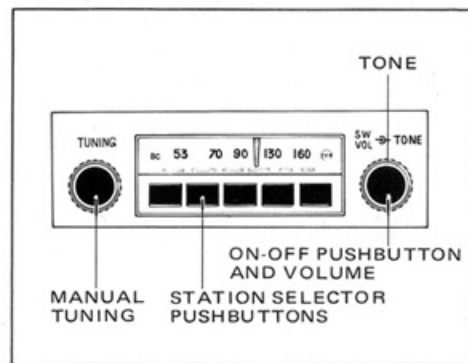

Push the ON-OFF switch to turn the radio on. Another push will turn it off.

If the engine is not running the key must be in the ACC position.

Adjust the length of your antenna for best reception. Usually a short length is best in large cities and a fully extended antenna is best for distant reception.

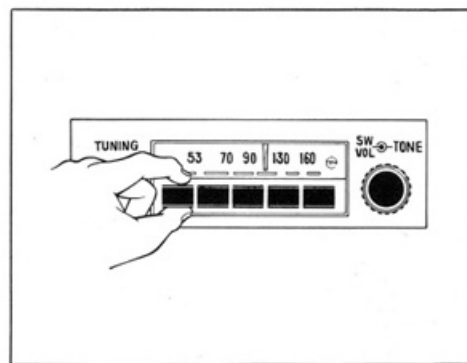

To set the station pushbuttons:

1. Pull a pushbutton out as far as it will go.
2. Tune in the desired station.
3. Push the button in as far as it will go.
4. Repeat this operation for the other pushbuttons.



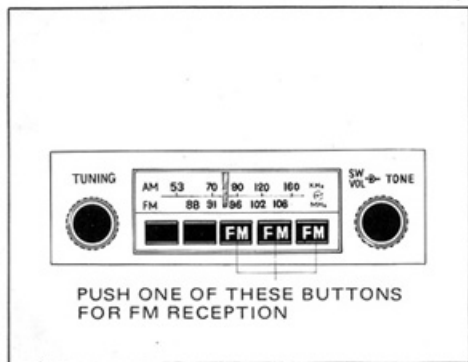

On AM-FM radios, you switch to FM reception by pressing in one of the three FM pushbuttons.

You should, of course, set these three buttons to FM stations. To switch back to AM reception, press one of the two unmarked pushbuttons.

FM broadcasts have a range of about 25 miles. When driving away from a station you may have to fine-tune your radio and turn up the volume as the station gets weaker. Because FM uses a "line-of-sight" signal, tall buildings, or hills may sometimes block reception. These are all normal characteristics of FM reception and do not indicate any problem with the radio itself.

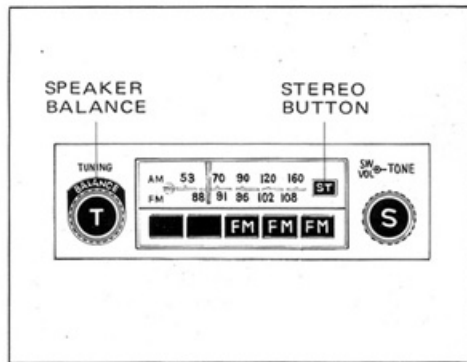

The AM-FM MULTIPLEX radio will receive stereo broadcasts with the ST button pushed in.

The button lights up during FM stereo reception. Pushing the button again switches back to FM monaural reception.

## Stereo cartridge player

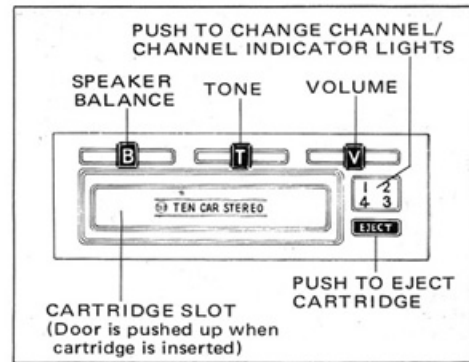

To play, simply insert the cartridge, label side up, into the slot as far as it will go.

This will automatically turn on the tape player and turn off the radio. The player will automatically switch at the end of each channel to the next one. You can manually advance to the next channel by pressing the program selector button.

## Stereo cassette player

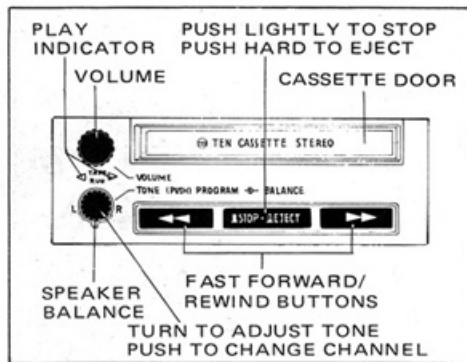

To play, simply insert the cassette into the slot as far as it will go.

This will automatically turn on the tape player and turn off the radio. The player will automatically change directions at the end of a tape to play the other channel. You can advance or rewind the tape or change channels with the controls on the player.

## The glove box

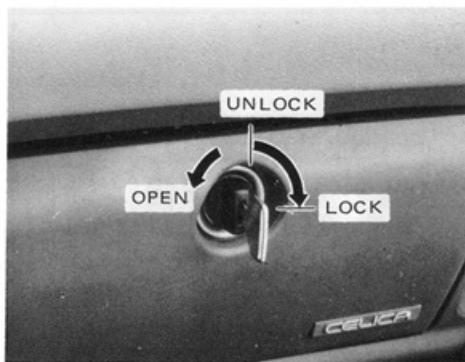

To open the door, unlock the door with your master key, and turn the knob counterclockwise.

## Day-night rear view mirror



Pull the lever to reduce glare in night driving.

Push the lever forward for normal daytime driving.

## Outside rear view mirror (GT)



To adjust the driver's side rear view mirror, simply move the control lever on the inside of the door.

If ice should jam the mirror control, don't force the control lever or scrape the mirror face. Use a spray de-icer to free the controls.

## The parking brake

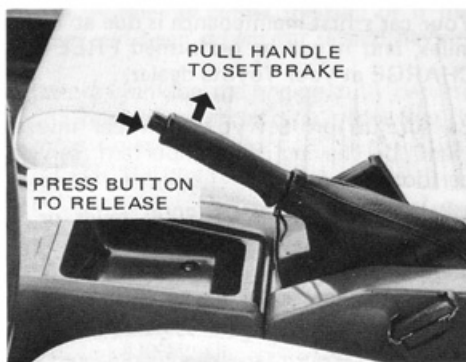

To set: Pull up on the lever.  
To release: Pull up slightly, press the thumb button, and lower.

As a reminder, the brake system warning light will come on if the parking brake is not fully released when the ignition is ON.

If the regular brakes should fail to operate while driving, you can make an emergency stop with the parking brake. However, the stopping distance will be much longer than normal.

## The locking fuel tank cap

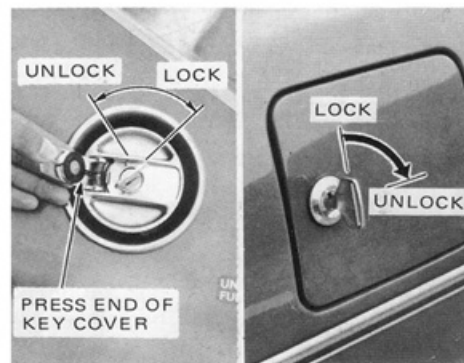

To remove the cap, open the key cover (hardtop), unlock the cap or fuel inlet cover (liftback) with your key, turn the cap counterclockwise, and lift it off.

It is not abnormal to hear a slight "swoosh" when the cap is opened. When you put the cap back on, align the tabs in the cap with the cutouts in the filler opening. On hardtop model, the cap does not lock automatically when it is reinstalled—the key must be used. If you desire, you may leave the cap unlocked.

## Hood release

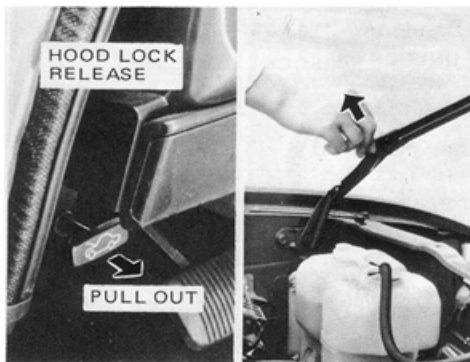

Pull the hood lock release under the dash and the hood will spring up about an inch. Lifting the hood completely will automatically lock it in that position.

To close the hood, pull the hood support with one hand while holding the hood with the other hand. Lower the hood and make sure it locks into place. If necessary, press down gently on the rear edge to lock it.

## Your responsibility for maintenance

Your car's first maintenance is due at 1000 miles, and it will be performed **FREE OF CHARGE** at your Toyota dealer.

Be sure to protect your new car investment by having this important service performed.

The next service is at 6000 miles or 6 months (whichever comes first) and at 6000-mi/6-mo intervals after that. However, under severe driving conditions, more frequent maintenance is required.

Your 1977 Toyota has been engineered for this long service interval to save you both time and money. However, each scheduled maintenance is more important than ever before to ensure smooth, safe, and economical driving. Section 5 gives full details of the maintenance requirements.

**Both the vehicle warranty and the emission control system warranty specify that scheduled maintenance must be performed.**

It is the owner's responsibility to make sure that the specified maintenance is performed. Your Toyota dealer's service department is trained and equipped to provide you with quality service.

## An important warning about the engine exhaust

**Avoid inhaling the engine exhaust.** It contains carbon monoxide, which is a colorless and odorless gas. It can cause unconsciousness or even death.

**Make sure the exhaust system has no holes or loose connections.** The system should be checked each time the oil is changed. If you notice a change in the sound of the exhaust, have the system checked immediately.

**Do not run the engine in a garage or enclosed area except for the time needed to drive the car in or out.** The exhaust gases cannot escape, making this a particularly dangerous situation.

**Keep the trunk lid or back door closed while driving.** An open or unsealed trunk or back door may cause exhaust gas to be drawn into the car. If you must drive with the trunk or back door open to accommodate a large object, you must force fresh air inside the car with the fan:

1. Close the windows.
2. Set the air intake lever at FRESH, the air flow lever at HEAT or VENT and the fan on HI.
3. Open the side vents.

**If you smell exhaust fumes in the car, drive with the windows down and the trunk lid closed. Have the cause immediately located and corrected.**

## How to start the engine

### Normal starting procedure (engine cold)

1. Fasten seat belts
2. Apply the parking brake
3. Turn off lights and accessories
4. **Automatic transmission:** Put the gear selector in P or N.

**Manual transmission:** Shift into neutral and hold down the clutch pedal until the engine is started.

5. Press the accelerator pedal *once* to the floor and release it. This sets the automatic choke and fast idle.
6. *With your foot off the accelerator pedal*, crank the engine by turning the key to START. Release it when the engine starts. Do not crank for more than 15 seconds at a time.
7. After the engine warms up for about 10 seconds, you're ready to drive. *Do not "race" a cold engine.*

### If the weather is below freezing or if the car has not been driven for several days....

- Before cranking the engine, fully depress and release the accelerator pedal *two or three times*. This gives a richer mixture for cold starting.
- Crank the engine *with your foot off the accelerator pedal*.
- After the engine runs for about 30 seconds, tap the accelerator to reduce its speed, and let it warm up for a few minutes before driving.

### If the engine is warm....

- Hold the accelerator pedal about halfway down while cranking the engine. Release it when the engine starts. *Do not pump the pedal.*
- If the engine is quite hot, press the accelerator fully to the floor while cranking.

### If the engine is warm or hot and won't start, it may be flooded....

- Depress the accelerator and hold it on the floor for 15 or 20 seconds.
- *While holding the accelerator to the floor*, crank the engine. It may take 20 or 30 seconds of continuous cranking to clear the excess fuel and start the engine. If the engine doesn't start, wait a few minutes and try again. Do not pump the accelerator—just continue holding it to the floor. (On cars equipped with catalytic converters, the warning light may come on for a few minutes until the excess fuel is cleared from the system.)

## Driving with a manual transmission

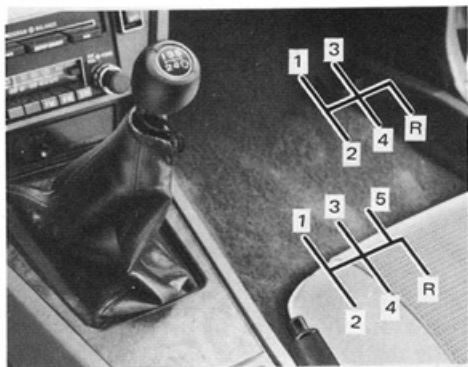

The shift pattern is conventional.

### Use the clutch correctly.

Press the pedal down fully while shifting, and then release it slowly. Do not rest your foot on the clutch while driving, because it will cause needless wear. And do not use the clutch to hold the car when stopped on an uphill grade—use the parking brake.

### Recommended shifting speeds.

For good fuel economy and long engine life you should upshift at the following speeds:

gear	approx. mph	km/h
1 to 2	15	24
2 to 3	25	40
3 to 4	40	64
(4 to 5)	45	72

Shifting too soon will cause lugging and, possibly, pinging. Regularly revving the engine to maximum speed in each gear will cause excessive engine wear and high gas consumption. Make sure the car is completely stopped before shifting into reverse.

### Maximum allowable speeds.

To get on a freeway or to pass slower traffic, maximum acceleration may be necessary. Make sure you observe the following maximum speeds in each gear:

gear	mph	km/h
1	29	47
2	51	82
3	77	123
4	104	167

### Good driving practice.

- When driving down a long hill, reduce your speed and downshift to a lower gear. The engine will provide a braking effect. (On cars with catalytic converters, the warning light may come on until you resume driving on level ground at the bottom of the hill.)
- If you slow to less than the following speeds (approx. 1300 rpm) such as when cornering, downshift to the next lower gear:

gear:	mph	km/h
2	10	16
3	15	24
4	25	40
(5)	30	48

The transmission is fully synchronized and downshifting is easy.

## Driving with an automatic transmission

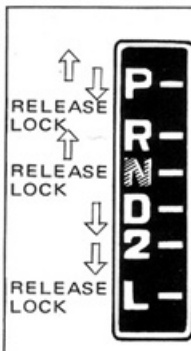

**PARK** Use to hold car in place after parking. The engine can be started in P. Never shift into P with the car moving.

**REVERSE** Use for backing up car. Shift into R after the car has stopped completely.

**NEUTRAL** No gears are engaged. The engine can be started in N — or restarted while moving.

**DRIVE** This is the position for normal driving.

**SECOND** Use for driving in heavy traffic or on mountain downgrades. Maximum speed: 66 mph (106 km/h).

**LOW** Use for hard pulling through sand, mud, or snow and for steep hills. Maximum speed: 42 mph (68 km/h).

The transmission uses a conventional sequence of gear positions.

The function of each of the selector positions is described in the illustration above. The lock release on the gear selector must be depressed to shift into Reverse, Park, Second or Low.

**For normal driving, put the selector in D range.**

The Toyota automatic is a highly efficient 3-speed unit. For best fuel economy, accelerate the car from a stop with gradually increasing pressure on the pedal. The transmission will automatically shift to second and drive.

If you need to accelerate rapidly, push the accelerator pedal all the way to the floor. The transmission will automatically downshift to second or low, depending on your speed.

### Using the 2 and L ranges.

With the selector in 2, the car will start in low, shift to second, but will not shift to Drive. With the selector in L, the transmission will not upshift at all. This gives you positive control over engine speed similar to that which you would have in a car with a manual transmission. The usual reason for selecting a lower gear is to obtain engine braking when driving in the mountains or in heavy traffic.

Be careful not to exceed the following speeds when accelerating:

Low	42 mph ( 68 km/h)
Second	66 mph (106 km/h)

The transmission is designed to guard against harmful engine overrevving when *downshifting*. If you select a lower gear but the car is traveling too fast, the transmission will delay downshifting until the car slows to the permissible speed.

### Good driving practice.

- Make sure the car comes to a complete stop before shifting into or out of Reverse.
- Never put the selector into Park until the car is fully stopped. And always use the parking brake. Don't count on the transmission to hold the car.
- When driving on slippery road surfaces, be careful when downshifting. The abrupt change in engine speed could cause the rear wheels to slip.
- After parking on a hill, the weight of the car may not allow the Park locking mechanism to release. If this should ever happen to you, the solution is simple: just drive *uphill* slightly. The mechanism will automatically unlock, and you can drive away.

## How to make your car last longer and save gas too

Making your Toyota last and getting the best possible fuel economy is easy—just take it easy! Drive moderately and avoid fast starts and hard stops. Here are some specific tips to help save you money in both gas and repairs:

- Avoid lengthy engine warm-up idling. Once the engine is running smoothly, begin driving—but gently until the engine is warmed up.
- Avoid unnecessary idling—shut off the engine.
- Accelerate slowly and smoothly.
- Look ahead while driving to avoid unnecessary stops and to maintain a steady speed.
- Don't hit the curb when parking, and slow down when driving on rough roads. This will help keep the front end in alignment and, if you have aluminum wheels, prevent damage to the wheel. (See page 68 for additional precautions for aluminum wheels.)
- Avoid high speeds. By reducing your speed from 70 to 50 mph (110 to 80 km/h), you'll reduce gas consumption by about 15 to 20 percent.
- Do not carry unnecessary weight in the car.

- Keep the tires inflated at the correct pressure. (The recommended tire pressure is printed on the lid of the glove box.)
- Use the air conditioner only when necessary.
- Don't rest your foot on the brake or clutch pedal while driving.
- With a manual transmission, be careful to neither lug nor overrev the engine while driving.
- Keep your car tuned up and in top shape by following the maintenance schedule given in Section 5.
- If you drive on dusty roads or for very short distances, make sure that your car receives more frequent maintenance. See Section 5 for details.

## Pretrip safety check

This checklist is for those many owners who like to "look over" their car themselves before starting out on a trip. It is a good idea. A few minutes of checking can help ensure safe and pleasant driving. Just a basic familiarity with cars is required—and a careful eye! Or, if you'd like, your Toyota dealer will be pleased to make this check for you at a nominal cost.

### Outside the car

**Tires.** Check the pressure with a gauge and look carefully for cuts, damage, or excessive wear.

**Wheel nuts.** Make sure no nuts are missing or loose.

**Exhaust system.** Look for cracks, holes, and loose supports. Start the engine and listen for any leakage. Have any leaks fixed immediately. (See carbon monoxide warning, page 22.)

**Fluid leaks.** After the car has been parked for a while, check underneath for leaking fuel, oil, water, or fluid. (Water dripping from the air conditioner after use is normal.)

**Windshield wiper blades.** Look for wear or cracks.



**Lights.** Make sure that the headlights, stop lights, tail lights, turn signals, and markers are all working. Check the headlight aim.

### Inside the car

**Brakes.** Make sure the brakes don't pull and that the pedal has enough clearance (see page 62.)

**Horn.** Does it work?

**Wiper and washer.** Make sure that they both work and that the wipers don't streak.

**Instruments and controls.** Especially make sure that the speedometer, warning lights, instrument lights, and defroster are working.

**Seat belts.** Check that the buckles lock securely. Make sure that the belts aren't worn or frayed.

**Spare tire and jack.** Check the tire pressure and make sure you have your jack and wheel nut wrench.

### Under the hood

**Engine oil level.** Check the dipstick with the car parked on a level spot. (See Section 6 for instructions.)

**Coolant level.** It should be near the upper mark on the see-through reservoir tank. (See Section 6 for instructions.)

**Automatic transmission fluid.** Check the dipstick with the engine idling and the gear selector in Park. (See Section 6 for instructions.)

**Radiator and hoses.** Make sure the front of the radiator is clean—not blocked with leaves, dirt, or bugs. Check the hoses for cracks, kinks, rot, and loose connections.

**Battery and cables.** All the battery cells should be filled to the proper level with distilled water. Look for corroded or loose terminals and a cracked case. Check the cables for good condition and connections.

**Wiring.** Look for damaged, loose, or disconnected wires.

**Brake and clutch fluid level.** It should be near the upper mark on the see-through reservoir.

**Fan belts.** They should not be frayed or oily. When pressed with your thumb they shouldn't give more than about ½ inch. (See page 52 for details on checking.)

**Fuel filter and lines.** Check the see-through filter for dirt or clogging. Check the lines for leaks or loose connections.

**Anything unusual?** Look for loose parts and leaks. Listen for abnormal noises. If everything looks O.K., set your mind at ease and enjoy your trip!

## Winter driving tips



### **Make sure you have ethylene-glycol coolant in the radiator.**

This is the type of coolant your new Toyota is delivered with and the type your dealer will always use. It has a definite pink or blue color and is not clear. In addition to preventing rust and lubricating the water pump, this coolant will prevent freezing and subsequent damage to the engine block.

### **Check the condition of the battery and cables.**

Cold temperatures reduce the capacity of any battery, so it must be in top shape to provide enough power for winter starting.

Section 6 tells you how to visually inspect the battery. Your Toyota dealer and most service stations will be pleased to check the level of charge.

### **Make sure the engine oil viscosity is suitable for the cold weather.**

See page 48 for recommended viscosity. Leaving a heavy summer oil in your car during winter months may cause harder starting. If you're not sure about which oil to use, call your Toyota dealer—he'll be pleased to help.

### **Check the spark plugs and ignition system.**

Make sure the plugs are not worn, fouled, or incorrectly gapped. (Section 6 has instructions for inspecting.) Visually check the rest of the system for loose connections or obvious damage.

### **Keep the door locks from freezing.**

Squirt lock de-icer or glycerine into the locks to keep them from freezing. To open a frozen lock, try heating the key before inserting it.

### **Put windshield washer antifreeze in the washer tank.**

This product is available at your Toyota dealer and most auto parts stores. Follow the manufacturer's directions for how much to mix with water. Do not use engine antifreeze or any other substitute because it may damage your car's paint.

### **Depending on where you're driving, you might carry a little emergency equipment.**

Some of the things you might put in the trunk are tire chains, window scraper, bag of sand or salt, flares, small shovel, jumper cables, etc.

# in case of an emergency—section 3

## If your car won't start



First, make these few simple checks....

● If the engine isn't turning over or is turning over too slowly—

1. If your car has an automatic transmission, make sure it is in Neutral or Park.
2. Under the hood, check both battery cables. Make sure that their connections to the battery, chassis, and starter are tight and clean.
3. Switch on the interior light. If it is out, dim, or gets dim when the starter is cranked, the battery is discharged. You may try jump starting (see next page) or, if your car has a *manual transmission*, push starting.

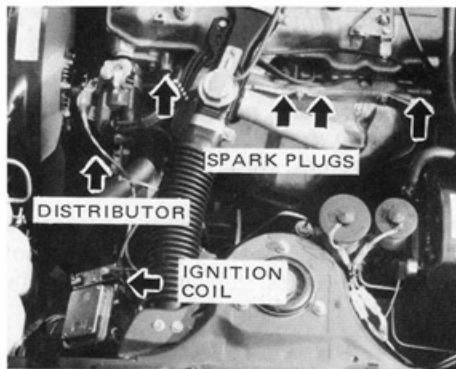

● If the engine turns over at its normal speed but will not start—

1. Check the gas gauge.
2. Under the hood, check that all the push-on connectors are tight at the coil, distributor, and spark plugs.
3. If the engine is warm or if you smell raw gasoline, the engine may be flooded—see the starting instructions on page 23. If it still won't start, remove and dry the spark plugs. Crank the engine for about 20 seconds, and reinstall the plugs.
4. If the engine still won't start, it needs adjustment or repair. Call a Toyota dealer or qualified repair shop for assistance.

## Procedure for push starting a car with a manual transmission.

A car with an automatic transmission cannot be push started.

1. Make sure the bumpers of the push car and your car match for a solid push. *Mismatched bumper height may lead to one bumper overriding the other, which could cause an accident.*
2. Turn the ignition key to ON, and shift into second gear.
3. Hold in the clutch and let the push vehicle slowly accelerate your car to about 10 mph (16 km/h). *Be aware that the brakes will be much harder to press when the engine is not running.*
4. At 10 mph (16 km/h), hold the accelerator about halfway down, and slowly release the clutch to start the engine.
5. As the engine starts, signal the push-car driver to stop. At the same time accelerate away from the push car to avoid a collision.

**Never tow a car to start it.** When the engine starts, the car may jump forward and hit the vehicle towing it.

## If your car won't start (cont.)

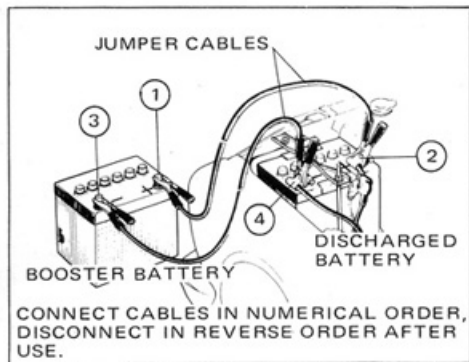

**Procedure for jump starting a car with a discharged battery.**

To avoid serious personal injury and damage to your car which might result from battery explosion, acid burns, electrical burns, or damaged electronic components, these instructions must be followed exactly. If you are unsure about how to follow this procedure, we strongly recommend that you seek the help of a competent mechanic or towing service.

**WARNING:** Batteries contain sulfuric acid. Wear protective safety glasses when jump starting, and avoid spilling acid on your skin, clothing, or car. If you should accidentally get acid on yourself or in your

eyes, flush immediately with water for at least five minutes, and then get immediate medical attention.

The gas normally produced by a battery will explode if a flame or spark is brought near. Therefore, do not smoke or light a match while jump starting.

The battery used for boosting must be 12-volt and negatively grounded. Do not jump start unless you are sure that the booster battery is correct.

1. Make sure that the vehicles are *not* touching. Turn off all unnecessary lights and accessories.
2. Remove all the vent caps from the booster and the discharged batteries. Lay a cloth over the open vents on both batteries. (These actions reduce the explosion hazard.)
3. If the engine in the vehicle with the booster battery is not running, start it and let it run for a few minutes.
4. Connect the jumper cables in the exact order shown in the illustration: *positive-to-positive (+)*, and *negative-to-negative (-)*. Note that you connect each cable first to the booster battery, and then to the discharged battery. *When making the connections, do not*

*accidentally allow the clamps to touch anything except the correct battery terminal. Do not lean over the battery when making the connections.*

5. Start your engine in the normal way. After starting, run it at a fast idle speed (1500 rpm) for several minutes.
6. Carefully disconnect the cables in the exact *reverse* order.
7. Carefully dispose of the battery cover cloths—they may now contain sulfuric acid.
8. Replace all the battery vent caps.

If the cause of your battery discharging is not apparent (for example, lights left on), you should have its condition checked.

## If your car overheats

**Pull safely off the road, stop the engine, and open the hood.**

**Then follow this procedure....**

1. Check the fan belt to see whether it is broken or loose. (Instructions for checking the tension are given in Section 6.)
2. Check the coolant reservoir. If it is dry, add water to the reservoir while the engine is running. Fill it about half full.  
**WARNING: Do not remove the radiator cap especially when the engine and radiator are hot.** Scalding hot fluid and steam may be blown out under pressure, which could cause serious injury.
3. Check for obvious coolant leaks. Look at the radiator, hoses, and under the car. (The see-through reservoir may not give an accurate indication of coolant loss when the engine is overheated.)
4. If the fan belt is O.K. and there are no obvious leaks, you may help the engine cool down more quickly by running it at a fast idle speed (about 1500 rpm) for a few minutes.

5. After the engine temperature has cooled to normal, again check the coolant level in the reservoir. If necessary, bring it up to half full again. Serious coolant loss indicates a leak in the system. You should have it checked as soon as possible at your Toyota dealer.

## If you lose your keys

**Many Toyota dealers can make a new key if you can give them the master key number.**

See the suggestion on page 3 for writing down the number on a card in your wallet.

If your keys are locked inside the car and you can't get a duplicate, many Toyota dealers can still open the door for you, using their special tools. If you must break a window to get in, we suggest breaking the smallest side window because it is the least expensive to replace. Be extremely cautious to avoid cuts from the glass.

## If you have a flat tire

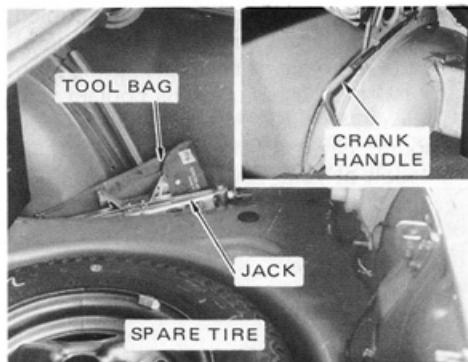

**1. HARDTOP:** Get the tool bag, jack, jack handle, and spare tire out of the trunk.

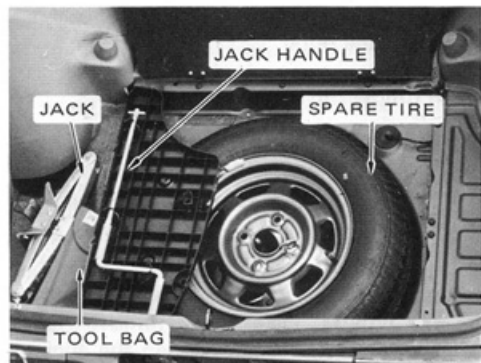

**LIFTBACK:** Get the tool bag, jack, jack handle, and spare tire out of the rear compartment.

**First,** make sure you are completely off the road—well away from the traffic. Avoid stopping on the center strip of a freeway. Park on a level spot with firm ground.

**Second,** turn on your emergency flashers (pull up on the switch).

**Third,** set the parking brake firmly and put the transmission in Park (automatic) or Reverse (manual).

**Fourth,** read these instructions thoroughly. They are designed to help a person who has never before changed a tire!

Note: If you have aluminum wheels, observe the special precautions given in steps 3, 7, 9 and 10. (See page 68 for additional information on aluminum wheels.)



**2. Block the wheel diagonally opposite the flat tire to keep the car from rolling when it is jacked up.**

To block the wheel "diagonally opposite" means simply this: Go to the side of the car that does not have a flat tire. If the front tire is flat, put the block *behind* the rear tire; if the rear tire is flat, put the block *ahead* of the front tire. This is a good safety precaution.

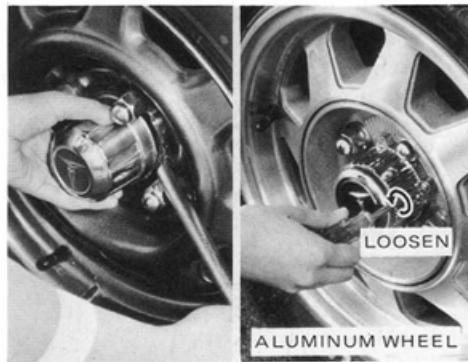

**3. Remove the wheel ring (GT), wheel hub ornament (ST & GT), or wheel cover.**

On steel wheels, push the beveled end of the wheel nut wrench under the edge of the ring, ornament, or cover and twist against the wheel. Loosen and come off. **Do not use your hands to pull them off.**

Note: On aluminum wheels, use a screwdriver to unscrew the 4 screws which hold the ornament in place.



**4. Loosen the four wheel nuts.**

You should always loosen the wheel nuts *before* raising the car.

The nuts turn *counterclockwise* to loosen. To get maximum force, fit the wrench to the nut so that the handle is on the left side, as shown above. Grab the wrench near the end of the handle and use your body weight to press down on the wrench. If necessary, use a hammer or rock to tap the end of the wrench handle to break loose the nut.

Do not remove the nuts yet. Just unscrew them about one-half turn.

## If you have a flat tire (cont.)



5. Position the jack as shown at the correct jack point.

Look for the two tabs on the underbody side seam.



6. Raise the car high enough for the spare tire to be installed.

To raise the car, insert the handle (it's a loose fit) into the jack and turn the handle *clockwise*. As the jack touches the car and begins to lift some weight, double-check that it is properly located. *Never get under the car when it is supported only by a jack.*

If the tire is quite flat, remember to raise the car enough so that the spare tire—which isn't flat at the bottom—will have clearance to fit on.



7. Remove the wheel nuts and change tires.

Use the ornament or cover as a tray for the wheel nuts to keep from losing them.

Lift the flat tire straight off and put it back into the trunk or rear compartment.

Note: Before putting the aluminum wheel, be sure to clean the areas where the wheel touches the wheel hub or brake drum.

Roll the spare wheel into position and align the holes in the wheel with the bolts. Then lift up the wheel and get at least the top bolt started through its hole. Wiggle the tire and press it back over the other bolts.





### 8. Reinstall the wheel nuts finger tight.

Reinstall the four wheel nuts (tapered end inward) and tighten them as much as you can by hand. Press the tire back and see if you can tighten them more.



### 9. Lower the car completely and tighten the wheel nuts.

Turn the jack handle *counterclockwise* to lower the car.

Use the wheel nut wrench to tighten the nuts in the order shown. Repeat the tightening several times—until the nuts cannot be tightened any more.

Note: On aluminum wheels, use only a Toyota wheel nut wrench and tighten the nuts firmly by hand. Do not use a hammer or other tool to tighten the nuts. Other tools or additional leverage could damage the wheel nuts or break the hub bolts.

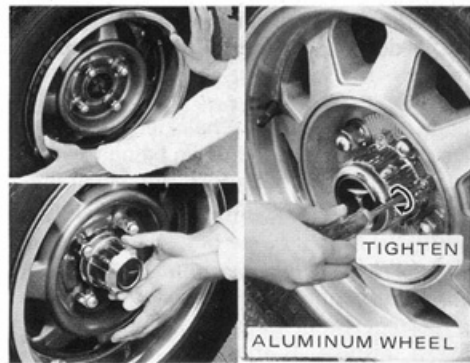

### 10. Reinstall the wheel hub ornament, wheel ring, or wheel cover.

On steel wheels, put the ornament, ring, or cover into position and then hit it firmly with the side or heel of your hand to snap it into place.

Note: On aluminum wheels, reinstall the hub ornament by screwing the 4 screws into place. Be careful not to overtighten the screws; it could damage the wheel.

That's all there is to it! Just make sure you get the jack, handle, wheel nut wrench, wheel block, and tire back into the car before driving away.

## If your car needs to be towed

If towing is necessary, we recommend you have it done by a commercial tow truck service.

Proper equipment will help ensure that your car is not damaged while being towed. And commercial operators are generally aware of the state and local laws pertaining to towing.

*Your car can be damaged if it is towed incorrectly.* Although most operators know the correct procedures, it is possible to make a mistake. Rather than risk damage to your car, why don't *you* make sure that the following few precautions are observed. If necessary, show this page to the tow truck driver.

### TOWING PRECAUTIONS:

- **General precaution:** The car may be towed from either the front or rear. The wheels and axle on the ground must be in good condition. If they are damaged, use a towing dolly.
- **Manual transmission—towing with rear wheels on ground:** Release the parking brake and put the transmission in Neutral.

- **Automatic transmission—towing with rear wheels on ground:** Release the parking brake and put the transmission in Neutral. *Do not tow faster than 30 mph (48 km/h) or farther than 50 miles.* If the car must be towed faster or farther, disconnect the driveshaft at the differential to avoid damaging the transmission.
- **Towing with front wheels on ground (either transmission):** The ignition key must be in the ACC position. The steering lock mechanism is not strong enough to hold the front wheels straight while towing. If necessary, use a dolly.

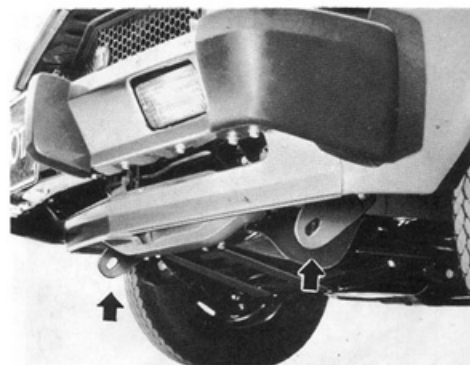

**For emergency towing, secure a cable or chain to one of the tie down tabs under the front of the car.**

A driver must be in the car to steer it and operate the brakes. *If the engine is not running, be prepared to press the brake pedal much harder than usual—it has no vacuum assist.* The wheels, axles, drive train, steering, and brakes must be undamaged.

Before towing, release the parking brake and put the transmission in neutral. *The key must be in ACC (engine off) or ON (engine running).*

## Washing and waxing your Toyota

**Wash your car in the shade when the body is not hot to touch. Use a mild car-wash soap and rinse it well.**

Dirt can cause small scratches in the paint and the chemicals in some dirt and air pollutants can cause deterioration of the paint and trim. Therefore, frequent washing is recommended. And if you drive or park your Toyota near the ocean, it's especially important.

Begin by rinsing all loose dirt off the car with a hose. If the underside has picked up mud or road salt, use a hard, direct stream from the hose to remove it.

**Wash** with a commercial car-wash product, which is available at your Toyota dealer or auto parts store. Follow the manufacturer's mixing instructions carefully. Do *not* use a strong household soap or detergent. Dip your sponge or cloth into the wash bucket frequently and don't rub too hard—let the soap water remove the dirt. If an optional vinyl top will not come clean with normal washing, use a mild, non-abrasive foaming cleanser with a soft bristle brush.

To clean white sidewall tires use a stiff brush or a house-hold steel-wool scouring pad.

Note: Your aluminum wheels are coated with a clear protective finish. Do not use any abrasive cleaners, polishing compounds, solvents, or wire brushes. It might scratch or damage this clear finish. Use only a mild soap or natural detergent and rinse thoroughly with water. Also, during winter, be sure to clean your aluminum wheels after driving on salted roads. This helps prevent corrosion. (If you are unsure whether you have aluminum wheels, see page 33.)

**Rinse** the car thoroughly. If any soap dries on the car it may cause streaking. In hot weather, you may have to rinse each section of the car right after you wash it.

**Dry** the car with a moist chamois or soft towel. The main purpose of drying is to remove excess water so that the car will air dry without water spots. So don't rub or press hard, which might scratch the paint.

**Polishing and waxing is recommended to maintain the original beauty of your Toyota's finish.**

Always wash and dry the car before you begin waxing, even if you are using a combined cleaner and wax. Road tar may be removed with turpentine. Use warm water and car-wash soap for insects and tree sap. Commercial products are also

## appearance care—section 4

available. *Do not use gasoline or strong solvents, which may be toxic or cause damage.*

Use a good quality polish and wax. If the finish has become extremely weathered, use a car-cleaning polish, followed by a separate wax. *Carefully follow the manufacturer's instructions and precautions.* Be sure to polish and wax the chrome trim as well as the paint.

Note: On aluminum wheels, do not use abrasive polishing compounds. (If you are unsure whether you have aluminum wheels, see page 33.)

Wax the car again when water does not bead up but remains on the surface in large patches.

**If you drive on salted roads in the winter or if you live near the ocean, you should periodically hose off the underside of the car to minimize rusting.**

Use a high-pressure hose to wash off all caked-on salt and mud. *Make sure that the brakes are fully dry before driving.* If the salt conditions are especially severe in your area, we recommend that the chassis be steam cleaned and undercoated for greater rust protection. Your local Toyota dealer will be happy to provide such a service or recommend where it can be done.

## Cleaning the interior

**The vinyl upholstery may be easily cleaned with a mild soap or detergent and water.**

Vacuum first to remove loose dirt. Then with a sponge or cloth, apply a soap solution to the vinyl. Allow it to soak for a few minutes to loosen the dirt. Then rub briskly with a clean, damp cloth to remove the dirt and rinse off the soap. If not all the dirt is removed, repeat the operation. Commercial foaming-type vinyl cleaners are also available which work well. Follow the manufacturer's instructions. *Do not use solvent, thinner, or gasoline.*

**Use a good foam-type shampoo to clean the carpets.**

Begin by vacuuming thoroughly to remove as much dirt as possible. Several types of foam cleaners are available: some are in aerosol cans and others are powders or liquids which you mix with water to produce a foam. To shampoo the carpets, use a sponge or brush to apply the *foam*. Rub in overlapping circles. Do not apply water—the best results are obtained by keeping the carpet as dry as possible. Read the shampoo instructions and follow them closely.

**The seat belts may be cleaned with mild soap and water or with carpet shampoo.**

Use a cloth or sponge. As you are cleaning, check the belts for excessive wear, fraying, or cuts. *Do not use dye or bleach on the belts—it may weaken them.*

**When cleaning the windows inside, be careful not to scratch or damage the heater wires on the rear window.**

You may use any household window cleaner. But do be careful not to damage the heater wires.

**If you have any questions about the cleaning of your Toyota, your local Toyota dealer will be pleased to answer them.**

# maintenance requirements—section 5

## Maintenance facts

### Regular maintenance is essential

We urge you to protect your new car investment by having your Toyota serviced according to the maintenance schedule given on the following pages. Regular maintenance will ensure:

- Maximum fuel economy
- Long vehicle life
- Maximum driving enjoyment
- Safety
- Reliability
- Full warranty protection
- Compliance with government regulations

Your Toyota has been designed for economical driving and economical maintenance. Many formerly required maintenance items are no longer required or are not required as often. Make sure that your car runs at peak efficiency and lasts a long time—follow the maintenance schedule.

### Where to go for service

It makes good sense to take your car to your local Toyota dealer for service. Toyota technicians are factory trained specialists. Every so often they take time off work to receive training and testing at one of our Toyota training centers. And

they are kept up to the minute with the latest service information through factory-issued technical bulletins, service tips, and in-dealership training programs. They learn to work on Toyotas *before* they work on your car, rather than *while* they're working on it. Doesn't that seem like the best way?

Your Toyota dealer has invested thousands of dollars in special Toyota tools and service equipment. It helps do the job better and at less cost. And when a part is needed, he'll probably have it on hand.

Your Toyota dealer's service department will perform *all* of the scheduled maintenance on your car—reliably and economically. Your copy of the repair order is proof that all required maintenance has been performed for warranty compliance. And if any problems should arise with your car while under warranty, your Toyota dealer will promptly take care of it. Again, be sure to keep a copy of the repair order for *any* service performed on your Toyota.

### What about do-it-yourself maintenance?

Many of the maintenance items are easy to do yourself if you have a little mechanical ability and a few basic automotive tools. These items are indicated on the maintenance schedule, and simple instructions for how to perform them are presented in

Section 6. Doing some of your own car maintenance will save you money.

Note, however, that some maintenance tasks require special tools and skills. These are best performed by qualified technicians. If you plan on doing only the simple maintenance items, your Toyota dealer will be pleased to perform the remaining service tasks.

If you are a skilled do-it-yourself mechanic, the Toyota factory service manuals are recommended. Please be aware that do-it-yourself maintenance can affect your warranty coverage. See your separate warranty statement for the details.

### Can the emission control system be converted?

Toyota Celicas have three different emission control systems — high-altitude, low-altitude and California specifications — within the same model.

Celicas of one specific specification are *not* designed to be converted to either of the other two specifications.

## The Toyota maintenance schedule

A mileage or time interval determines when service is necessary.

For most people, the odometer mileage will indicate when service is needed. If, however, you drive very little, your car should be serviced at least every 6 months, as shown on the schedule. Under severe driving conditions, more frequent maintenance is required.

Each maintenance item is numbered and is described on the pages following the schedule.

If you want to know exactly what a maintenance item consists of, refer to that item number in the task descriptions that begin on page 46.

Maintenance items for which do-it-yourself instructions are given in this manual (Section 6) are indicated by an \*.

You can use the asterisks to quickly locate those items you may wish to do yourself. Be sure to mark down those items that you have completed. If you are going to have your Toyota dealer complete the scheduled maintenance by doing the more skilled tasks, he will need exact information on what has already been done.

## Toyota maintenance schedule

Maintenance operations: A=Check and/or adjust as necessary; I=Inspect and correct or replace as necessary; R=Replace or change

SERVICE INTERVAL: (Use odometer reading or months, whichever comes first)	Mileage x 1000	1	6	12.5	19	25	31	37.5	44	50
	or Months	1	6	12	18	24	30	36	42	48
<b>BASIC ENGINE COMPONENTS</b>										
1	Valve clearances . . . . .	A	.	A	.	A	.	A	.	A
2*	Drive belts . . . . .	A	.	I	.	R	.	I	.	R
3	Engine bolts . . . . .	A	.	.	.	.	.	.	.	.
4*	Engine oil and oil filter . . . . .	.	R	R	R	R	R	R	R	R
5*	Engine coolant . . . . .	.	.	.	.	R	.	.	.	R
6	Cooling system hoses and connections . . . . .	.	.	I	.	I	.	I	.	I
7	Vacuum fittings, hoses and connections . . . . .	.	.	I	.	I	.	I	.	I
8	Exhaust system . . . . .	.	.	I	.	I	.	I	.	I
<b>FUEL SYSTEM</b>										
9	Idle speed and idle mixture . . . . .	A	.	A	.	A	.	A	.	A
10	Choke system . . . . .	.	.	A	.	A	.	A	.	A
11	Fuel filter . . . . .	.	.	.	.	R	.	.	.	R
12*	Air filter . . . . .	.	.	I	.	R	.	I	.	R
13	Inlet air temperature control valve . . . . .	.	.	I	.	I	.	I	.	I
14	Throttle positioner system . . . . .	.	.	I	.	I	.	I	.	I
15	Fuel tank cap, gas lines and connections . . . . .	.	.	.	.	I	.	.	.	I
16	Fuel tank cap gasket . . . . .	.	.	.	.	R	.	.	.	R
17	Auxiliary accelerator pump . . . . .	.	.	I	.	I	.	I	.	I
<b>IGNITION SYSTEM</b>										
18	Dwell angle and ignition timing . . . . .	I	.	I	.	I	.	I	.	I
19	Distributor breaker points . . . . .	.	.	.	.	R	.	.	.	R
20*	Spark plugs . . . . .	.	.	R	.	R	.	R	.	R
21	Ignition wiring . . . . .	.	.	I	.	I	.	I	.	I
22	Distributor cap and rotor . . . . .	.	.	I	.	I	.	I	.	I
23	Distributor advance . . . . .	.	.	I	.	I	.	I	.	I
24	Spark control system . . . . .	.	.	I	.	I	.	I	.	I
<b>CRANKCASE EMISSION CONTROL SYSTEM</b>										
25	PCV system . . . . .	.	.	I	.	I	.	I	.	I
26	PCV valve . . . . .	.	.	.	.	R	.	.	.	R

\*: Do-it-yourself instructions are given in Section 6.

Maintenance operations: A=Check and/or adjust as necessary; I=Inspect and correct or replace as necessary; R=Replace or change

SERVICE INTERVAL: (Use odometer reading or months, whichever comes first)	Mileage x 1000	1	6	12.5	19	25	31	37.5	44	50
	or Months	1	6	12	18	24	30	36	42	48

**EXHAUST EMISSION CONTROL SYSTEM**

27	Air injection system			I		I		I		I
----	----------------------	--	--	---	--	---	--	---	--	---

**FUEL EVAPORATIVE EMISSION CONTROL SYSTEM**

28	Carbon storage canister			I		I		I		R
29	Fuel vapor storage system, hoses and connections			I		I		I		I

**ELECTRICAL SYSTEM**

30	Wiring harness and connections			I		I		I		I
----	--------------------------------	--	--	---	--	---	--	---	--	---

**CHASSIS AND BODY**

31*	Brake pedal, clutch pedal and parking brake		I	I	I	I	I	I	I	I
32	Rear brake linings and drums			I		I		I		I
33	Front brake pads and discs			I		I		I		I
34	Brake lines and hoses			I		I		I		I
35*	Brake fluid level		I	I	I	I	I	I	I	I
36*	Steering wheel, linkage and gear box oil			I		I		I		I
37	Ball joints and dust covers			I		I		I		I
38*	Manual transmission, and differential oil			I		I	R	I		R
39*	Automatic transmission fluid			I		I	R	I		R
40*	Wheel bearing and ball joint grease					R				R
41	Front suspension upper support bearing grease					R				R
42	Bolts and nuts on chassis and body	A		A		A		A		A
43	Emergency locking retractor system		I	I	I	I	I	I	I	I
44	Seat belt warning system			I		I		I		I

\*: Do-it-yourself instructions are given in Section 6.

## Explanation of maintenance items

### BASIC ENGINE COMPONENTS

**1. Adjust valve clearances.** With the engine warm, the valve clearance should be adjusted to factory specifications. This adjustment should be made by a qualified technician.

**2. Inspect, adjust, or replace drive belts.** Inspect the engine drive belts for cracks, excessive wear, or stretching. Adjust the belts to the specified deflection. When scheduled, replace the belts. Check the tension after 1000 miles. Do-it-yourself instructions are given in Section 6.

**3. Tighten engine bolts.** At 1000 miles, retighten the cylinder head bolts to the specified torque. *For subsequent inspection*, make sure these bolts are tight. If loose, retorque them to specifications.

**4. Change engine oil and oil filter.** Change the engine oil and filter when scheduled. Do-it-yourself instructions are given in Section 6. Use only API grade SE oil of the proper viscosity for your climate. Under the following *severe driving conditions*, change the engine oil and filter every 3000 miles or 3 months, whichever comes first:

- Driving in extremely cold weather
- Pulling a trailer

- Driving primarily short distances
- Driving on dirt roads

**5. Change engine coolant.** Drain and flush the cooling system when scheduled. Refill only with an ethylene-glycol type coolant. Do-it-yourself instructions are given in Section 6.

**6. Inspect cooling system hoses and connections.** Inspect the hoses and connections for leakage, swelling, or cracks. Replace any deteriorated or damaged parts.

**7. Inspect vacuum fittings, hoses, and connections.** Inspect all vacuum hoses and fittings for leakage, clogging, or damage. Replace any damaged parts. Make sure the hoses are connected as indicated on the underhood diagram.

**8. Inspect exhaust system.** Visually inspect the exhaust manifold, pipes, muffler, and hangers for cracks, deterioration, or damage. Start the engine and listen carefully for any exhaust gas leakage. Tighten connections or replace parts as necessary.

### FUEL SYSTEM

**9. Adjust idle speed and idle mixture.** Make sure that all carburetor parts are secure and that the linkage operates smoothly. (Do not lubricate.) Check for

correct float level, choke operation, and ignition timing. Then adjust the idle speed, fast idle speed, and idle mixture to factory specifications. No idle mixture adjustment is to be made at the 1000 mile maintenance. These checks and adjustments should be done by a qualified technician.

**10. Adjust choke system.** Check for correct choke operation. Adjust the fast idle speed. This inspection and adjustment require a qualified technician.

**11. Replace fuel filter.** Make sure the replacement filter is installed correctly. This filter cannot be cleaned.

**12. Inspect or replace air filter.** Visually check the filter for dirt or damage. It may be cleaned with compressed air. Replace when scheduled. Do-it-yourself instructions are given in Section 6.

NOTE: If you are driving regularly on dusty roads, inspect and clean the element every 4000 miles or 4 months and replace it every 25000 miles or 24 months, whichever comes first.

**13. Inspect inlet air temperature control valve.** Check for proper operation of the valve. The cold air inlet should be opened when the engine is warm. Do not move the valve by force. Replace if inoperative.



**14. Inspect throttle positioner system.** Check for correct operation of the throttle positioner system. Adjust TP speed if necessary. A qualified technician should perform these operations.

**15. Inspect fuel tank cap, gas lines, and connections.** Visually inspect for corrosion, damage, cracks, and loose or leaking connections. Tighten connections or replace parts as necessary.

**16. Replace fuel tank cap gasket.** Make sure the new part is correctly installed.

**17. Inspect auxiliary accelerator pump.** With the engine cold, the auxiliary accelerator pump should operate. Once warm, it should not. A qualified technician should make this inspection.

## IGNITION SYSTEM

**18. Inspect dwell angle and ignition timing.** Set to factory specifications. A qualified technician should perform this inspection.

**19. Replace distributor breaker points. (except Calif. GT model)** When scheduled, replace the points and reset the dwell angle (point rubbing block gap) and timing. A qualified technician must perform these operations.

**20. Replace spark plugs.** Make sure to

install plugs of the correct heat range. Do-it-yourself instructions are given in Section 6.

**21. Inspect ignition wiring.** Visually inspect for burned terminals, cracks, or damage. Measure that the end-to-end resistance is within specification. A qualified technician should make this measurement.

**22. Inspect distributor cap and rotor.** Visually inspect for cracks, burned electrodes, wear, or corrosion. Clean thoroughly. Replace any damaged parts.

**23. Inspect distributor advance.** Check to make sure that both the mechanical and vacuum advance are working smoothly. A qualified technician should make this check.

**24. Inspect spark control system.** Check for correct operation of the spark control system. Replace any damaged parts. A qualified technician must perform this inspection.

## CRANKCASE EMISSION CONTROL SYSTEM

**25. Inspect PCV system.** Check for proper operation of the valve and clean or replace if necessary. Look for deteriorated or clogged hoses or leaking connections. Clean or replace any damaged parts.

**26. Replace PCV valve.** When scheduled, replace the valve. Make sure that the new valve is correctly installed.

## EXHAUST EMISSION CONTROL SYSTEM

**27. Inspect air injection system.** Look for deterioration or loose hose connections. Check for proper functioning of the vacuum transmitting valve. This inspection must be performed by a qualified technician.

## FUEL EVAPORATIVE EMISSION CONTROL SYSTEM

**28. Inspect or replace carbon storage canister.** Inspect for internal damage or clogging. Replace when scheduled. A qualified technician should perform this check.

**29. Inspect fuel vapor storage system, hoses, and connections.** Inspect the fuel tank, tank cap, and hoses for leakage, deformation, or damage. Replace any damaged parts.

## ELECTRICAL SYSTEM

**30. Inspect wiring harness and connections.** Look for burned, loose, or damaged

## Explanation of maintenance items (cont.)

wires or connections. Repair or replace if necessary.

### CHASSIS AND BODY

**31. Inspect brake pedal, clutch pedal, and parking brake.** Check the brake-pedal-to-floor clearance, the clutch pedal freeplay, and parking brake adjustment. Check brake booster operation. Do-it-yourself instructions are given in Section 6.

**32. Inspect rear brake linings and drums.** Check for scoring, burning, leaking fluid, broken parts, and excessive wear. A qualified technician should make this inspection.

**33. Inspect front brake pads and discs.** Check the pads for excessive wear and the discs for runout and wear. A qualified technician should make this inspection.

**34. Inspect brake lines and hoses.** Visually check for damage or evidence of leaking. Replace any damaged parts.

**35. Inspect brake fluid level.** Check the brake and clutch fluid levels. Replenish if necessary. Do-it-yourself instructions are given in Section 6.

**36. Inspect steering wheel, linkage, and gearbox oil.** With the vehicle stopped, check for excessive freeplay in the steering

wheel. Check the steering gearbox for leakage and, if necessary, replenish the gearbox oil. Do-it-yourself instructions for this check are given in Section 6.

**37. Inspect ball joints and dust covers.** Check front suspension ball joints for looseness and the dust covers for deterioration or damage. A qualified technician should perform any repairs needed.

**38. Inspect or change manual transmission and differential oil.** Check that the oil level is just below the filler plug. If necessary, replenish. Inspect each component for signs of leakage. When scheduled, drain and change the oil. Do-it-yourself instructions are given in Section 6.

**39. Inspect or change automatic transmission fluid.** With the engine idling, shift through all gears and then into P. Check the fluid level on the dipstick. If necessary, replenish. When scheduled, drain the fluid and replace with new fluid. Do-it-yourself instructions are given in Section 6.

**40. Lubricate wheel bearings and ball joints.** Repack the front wheel bearings with wheel bearing grease. Lube the ball joints with molybdenum-disulphide lithium base grease using a grease gun. Do-it-yourself instructions for ball joint greasing are given in Section 6.

**41. Lubricate front suspension upper support bearings.** Repack the front suspension upper support bearings with multipurpose grease.

**42. Tighten bolts and nuts on chassis and body.** Where necessary, retighten to specified torque.

**43. Inspect emergency locking retractor system.** At a safe place, check that the system locks the seat belts in a "panic" stop from 10 mph (16 km/h).

**44. Inspect seat belt warning system.** With the seat belts unfastened, check that the warning light and buzzer work when the ignition key is at ON. With the seat belts fastened, the warning light should work but the buzzer should not.

## Does your car need a repair?

Be on the alert for changes in performance, sounds, and visual tip-offs that indicate service is needed. Some important clues are as follows:

- Engine missing, stumbling, or pinging
- Appreciable loss of power
- Strange engine noises
- A leak under the car (however, water drainage from using the air conditioner is normal.)
- Change in exhaust sound (this may indicate a dangerous carbon monoxide leak. Drive with the windows down and have it checked immediately.)
- "Flat"-looking tire; excessive tire squeal when cornering; uneven tire wear
- Car pulls to the side when driving straight on a level road
- Strange noises related to suspension movement
- Loss of brake effectiveness; "spongy" feeling brake or clutch pedal; pedal almost touches floor; brakes pull to one side when stopping
- Engine temperature continually higher than normal

If you notice any of these clues, take your car as soon as possible to a Toyota dealer. It probably needs an adjustment or repair.



## The Celica 20R engine

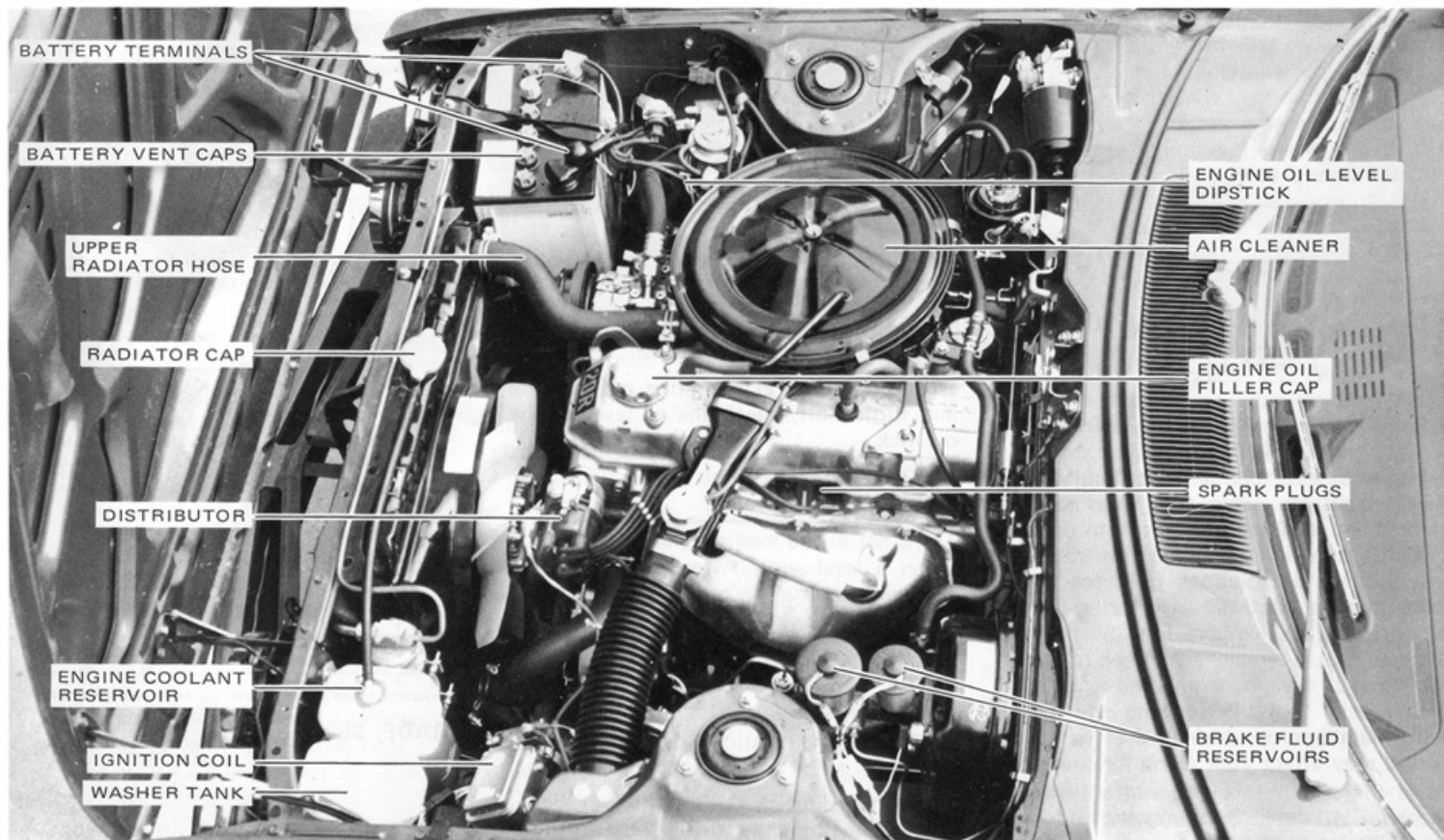

## Do-it-yourself service precautions

As with any machinery, extreme care should be taken when working on your car to prevent accidental injury. Here are a few precautions that you should be especially careful to observe:

- When the engine is running, keep hands, clothing, and tools away from the moving fan and fan belt. (Removing rings, watches, and ties is advisable.)
- Don't allow smoking, sparks, or open flames around gasoline or the battery. The fumes are flammable.
- Don't get under your car with just the body jack supporting it. Always use automotive jack stands or other solid supports.
- Remember that battery and ignition cables carry high currents or voltages. Don't cause accidental short circuits.

You should be aware that improper or incomplete servicing may result in operating problems or excessive emissions. This section gives instructions only for those items that are relatively easy for an owner to perform. As explained in Section 5, there will still remain a number of items that must be done by a qualified technician with special tools. **Performing do-it-yourself maintenance during the warranty period may affect your warranty coverage.** Read the separate Toyota warranty statement for full details and suggestions.

## Checking the engine oil level



**With the engine at operating temperature and turned off, check the oil level on the dipstick.**

**TOOLS REQUIRED:**  
Rag or paper towel

1. To get a true reading, the car should be on a level spot. After turning off the engine, wait a few minutes for the oil to drain back into the bottom of the engine.
2. Pull out the dipstick, and wipe it clean with a rag.
3. Reinsert the dipstick—push it in as far as it will go or the reading will be wrong.
4. Pull the dipstick out and look at the oil level on the end. If it is between the F

and L marks, it is O.K. If the oil level is below the L mark (or not even showing on the dipstick), add 1 quart (1 liter) of oil immediately. Oil grade and viscosity recommendations are given below.

### VISCOSITY:

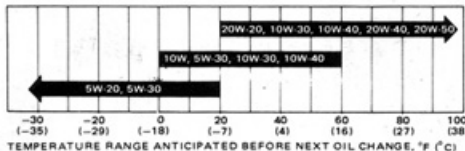

**GRADE: SE or Better**

## Changing the engine oil and filter

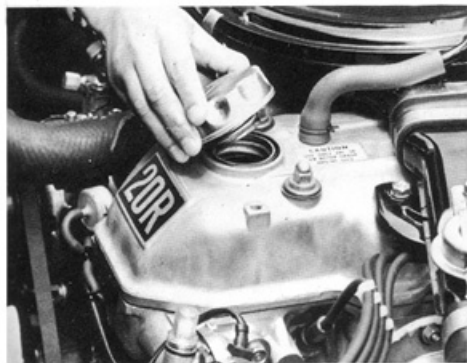

1. Warm up the engine for a few minutes and remove the oil filler cap.

### PARTS REQUIRED:

1 oil filter: Nipponenso 15601-44010  
5½ quarts engine oil, Grade SE

### TOOLS REQUIRED:

24mm wrench or adjustable wrench  
6-quart or larger drain pan  
Oil filter wrench  
Oil can spout or funnel & can opener

- a. Park the car on a level spot. Warm up the engine until the needle on the temperature gauge is at least above the bottom mark. (The warm oil will drain faster and more fully.) Stop the engine.
- b. Remove the oil filler cap. This allows air to enter the engine as the oil drains.

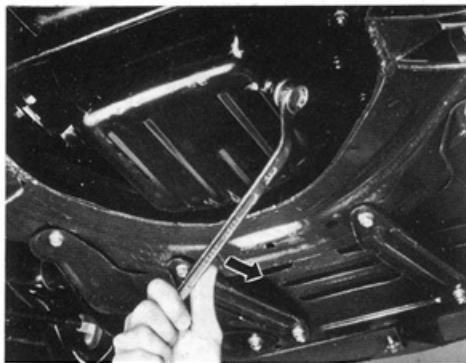

2. Drain the oil and reinstall the drain plug.

- a. Place a drain pan under the drain plug.
- b. Using a wrench, remove the drain plug. *The oil may be hot—be careful not to burn yourself.* Allow the oil to drain fully.
- c. Reinstall the drain plug and gasket. Tighten the plug with your wrench, but don't force it and strip the threads.

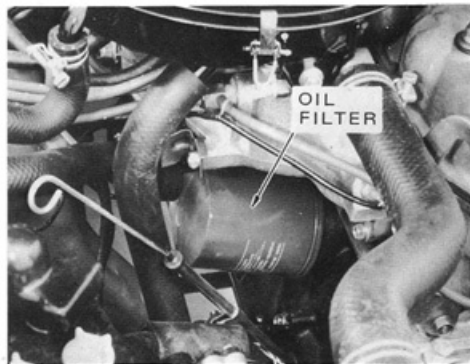

3. Remove the old oil filter and install a new one, hand tight.

- a. Using an oil filter wrench (any of several common types will work), loosen the oil filter. It turns counterclockwise. Once loose, you may unscrew it the rest of the way by hand. When removing it, hold up the end so that oil doesn't spill out.
- b. With a clean rag, wipe off the mounting surface on the engine so that the new filter will seat well.
- c. Smear a little engine oil on the rubber gasket of the new oil filter.
- d. Screw the new filter into place. Tighten it as firmly as you can *by hand*. Do not use the wrench to tighten it.

## Changing the engine oil and filter (cont.)



4. Add oil and install the filler cap. Start the engine and check for leaks at the filter or drain plug.

- After adding the oil, make sure that the filler cap is installed hand-tight. You may double-check the oil level on the dipstick.
- With the engine running, look carefully for any small leaks from around the oil filter or drain plug. Any leak indicates a faulty installation.
- Then stop the engine and wait a few minutes. Check the oil level again and add oil if necessary.

## Checking the engine coolant level

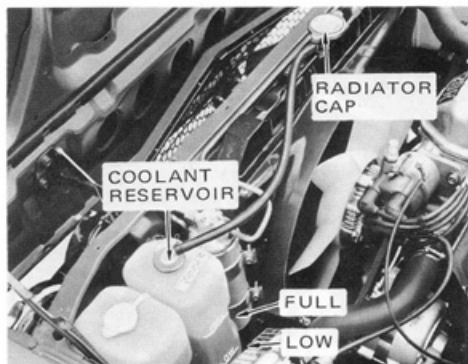

Look at the see-through coolant reservoir tank. The coolant level is satisfactory if it is between the FULL and LOW lines on the tank.

The coolant level in the reservoir tank will vary with engine temperature. However, if the level is on or below the LOW line, add coolant. Bring the level up to the FULL line.

*Use only ethylene-glycol-type coolant.* It will prevent freezing and rust. Supplemental inhibitors or additives are neither needed nor recommended.

If the coolant level drops within a short time after replenishing, there may be a leak

in the system. Visually check the radiator, hoses, radiator cap and drain cock, and water pump.

If no leak can be found, have the cap pressure tested at your Toyota dealer. **Do not remove the radiator cap when the engine is hot.** See page 31 for instructions and precautions.



## Changing the engine coolant

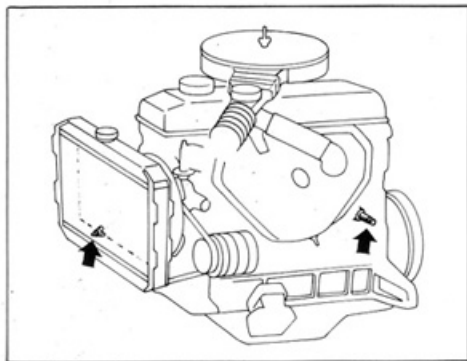

### 1. Drain the cooling system and flush it out with water.

#### PARTS REQUIRED:

1 gallon (or more) ethylene-glycol coolant (do not use alcohol type).

#### TOOLS REQUIRED:

14-mm wrench or adjustable wrench.  
Garden hose or funnel and bucket.

- Park the car on a level spot, where the coolant can drain into a suitable disposal container.
- Remove the radiator cap. **Do not remove the cap if the engine is hot.**
- Loosen (turn counterclockwise) the plugs in the two drain cocks: one at the

bottom of the radiator and one at the right side of the engine. **If the engine is warmed up, use care to avoid burning yourself with the hot coolant.**

d. Read the ethylene-glycol container for information on freeze protection. We recommend that no *less* than 1 gallon of ethylene-glycol be used in your Celica. This is about a 50% mixture, which prevents freezing down to about  $-32^{\circ}\text{F}$  ( $-36^{\circ}\text{C}$ ) and provides necessary rust prevention and water pump lubrication. (Additional freeze protection may be obtained by adding a greater amount of ethylene glycol.)

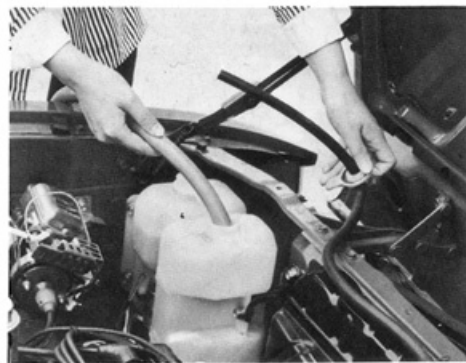

### 2. Close the two drain plugs and fill the system with coolant and water. Install the radiator cap.

- Make sure that both drain plugs are securely tightened.
- Pour the ethylene-glycol coolant into the radiator. Then fill with clean water until the radiator is full.
- Start the engine, and top off the radiator with water. Fill the reservoir half full.
- Install the radiator and reservoir caps and double-check that the drain plugs are not leaking.

## Checking the engine drive belts

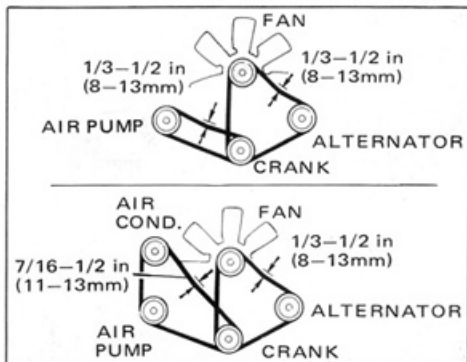

Visually inspect the condition of the belts. Check their tension by applying thumb pressure midway between the pulleys.

- With the engine turned off, check the belts for cracks, fraying, or excessive wear. Have belts in poor condition replaced by your Toyota dealer.
- With your thumb, press hard on each belt midway between the pulleys. Each belt should deflect *no more* than the amount shown above. If a belt is loose, tighten it, as described in the next step.

## Adjusting the engine drive belts

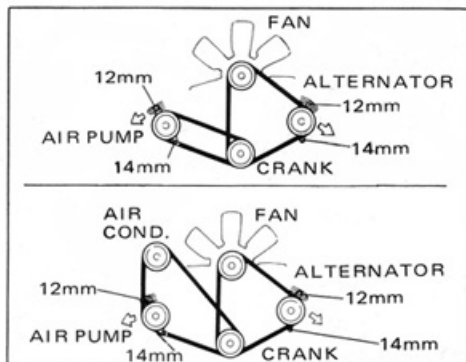

1. Loosen the two adjusting bolts on either the alternator, or air pump, depending on the belt you wish to tighten.

**TOOLS REQUIRED:**  
12 and 14-mm wrenches.  
Large screwdriver or pry bar.

a. Loosen the bolts just enough so that the component can be moved.

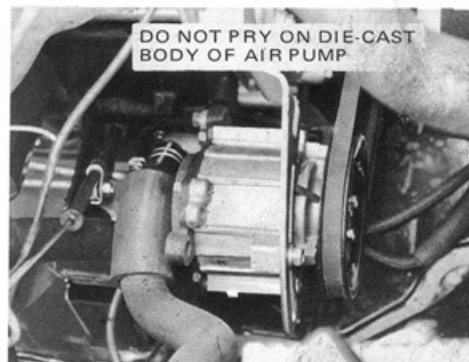

2. Use the screwdriver or bar to pry the moveable component outward until the desired belt tension is reached. While holding the tension, tighten the adjusting bolts.

- While pulling outward on the pry bar or screwdriver, test the belt deflection with your thumb.
- After tightening the adjusting bolts, be sure to recheck the belt tension.

## Checking and replacing the air cleaner element

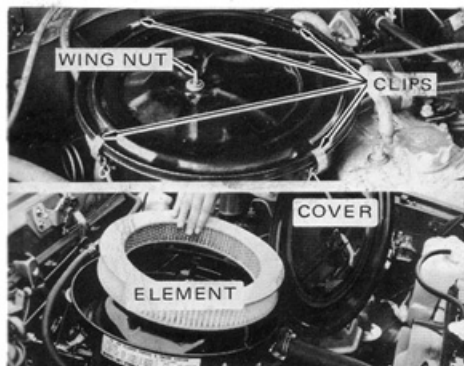

1. To inspect the element, unscrew the wingnut and release the four clips. Then remove the cover and lift out the element.

- The wingnut can be unscrewed by hand.
- Lift the wire tab to release each clip.
- Lift off the cover and set it aside.

Lift out the paper element and look at its outer surface. If it is dirty, it should be replaced.

(NOTE: If the element is just moderately dusty, it may be cleaned by blowing compressed air from the *inside* outward. Do *not* wash or oil the element.) Do *not* drive with the air cleaner removed. Backfiring could cause a fire under the hood.

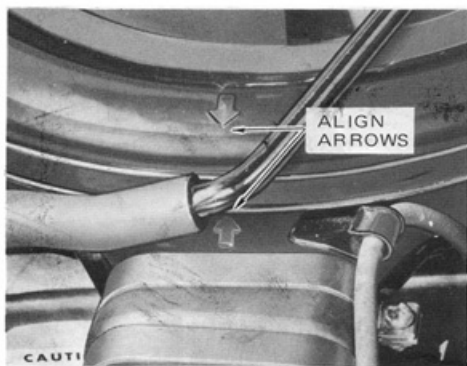

2. After installing an element, make sure the arrows on the cover and case are aligned. Then fasten the clips and screw on the wingnut.

---

PARTS REQUIRED:  
1 Nippondenso air cleaner element  
17801-41050

---

- When installing an element, make sure it is properly centered in the case.
- Do not overtighten the wingnut or the carburetor may be damaged.

## Replacing spark plugs

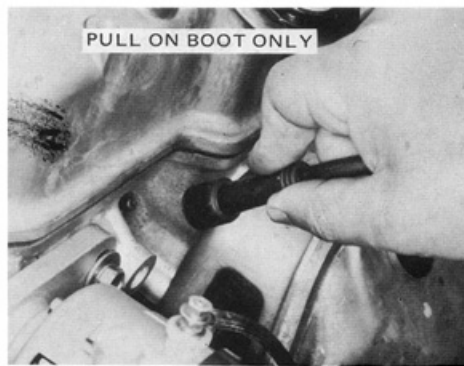

1. Unfasten the spark plug cables by pulling on the boot, not on the cable itself.

---

PARTS REQUIRED:  
4 spark plugs  
Nippondenso W16EP, W16EX-U,  
NGK BP5ES-L, BP5EA-L or equivalent.

TOOLS REQUIRED:  
Spark plug wrench  
Combination spark plug gauge and  
gapping tool.

---

- Note the order of the spark plug cables. If you are not positive that you can reconnect them correctly, mark each cable with a number on a piece of tape before disconnecting it.

## Replacing spark plugs (cont.)

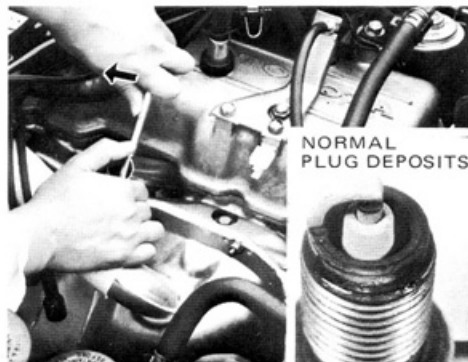

b. Unfasten the connector by pulling straight up. *Pulling on the cable may break the carbon wire inside.*

**2. Unscrew and remove the old spark plugs with their metal gaskets.**

a. Keep the plugs in order as you remove them. If the plugs have anything other than brown to light tan (or grey) deposits on them, save them, and show them to your Toyota dealer. They may indicate adjustments or repairs needed. If the deposits are normal, discard the plugs.

b. Make sure that no metal gaskets were accidentally left in place. A double gasket could cause leakage. *Do not allow dirt or anything else to fall through the spark-plug holes.*

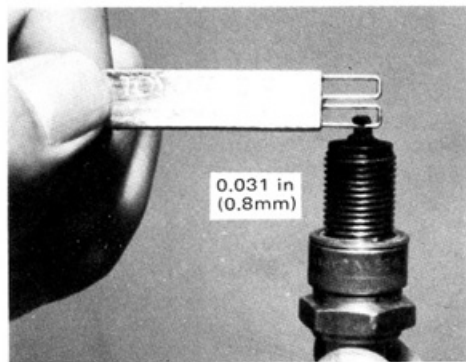

**3. Set the gap on the new plugs to 0.031 inch (0,8mm), and install them. Reconnect the spark plug cables in the correct order.**

a. Check the gap by passing the 0.031-in. (0.8mm) feeler gauge between the electrodes on the spark plug. If the gap is correct, you will feel a slight drag. If necessary, bend the outer electrode to obtain the right clearance.

b. Make sure that each plug has a *new* gasket. Do not reuse old gaskets.

c. After screwing in the plugs, tighten them up firmly with the spark plug wrench, but don't overtighten.

d. Make sure the cables are installed in the correct order. The connector fastens on by pushing it squarely over the end of the spark plug.

## Checking battery condition and fluid level

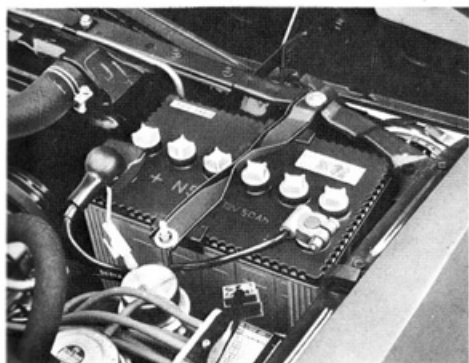

1. Check the battery for corroded or loose connections, cracks, or loose hold-down clamps.

The fumes generated by the battery can be explosive. Therefore, do not allow open flames, sparks, or smoking nearby.

a. If the battery is corroded, wash it off with a solution of warm water and baking soda. Coat the outside of the terminals with grease to prevent further corrosion.

b. If the connections are loose, tighten the clamp bolts—but do not overtighten.

c. Tighten the hold-down clamp only enough to keep the battery firmly in place. Overtightening may damage the battery case.

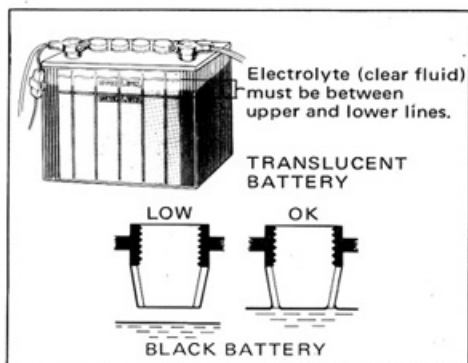

2. Depending on the type of battery installed in your car, check the electrolyte level as shown above. If the level is low, add distilled water.

Do not get electrolyte which is an acid, in your eyes or on your skin or clothes! If you should contact it, flush the area with water for 5 minutes and contact a physician.

a. When checking the electrolyte level, look at all six cells, not just one or two.

b. Use only distilled water to replenish the battery. **Do not overfill**—the electrolyte may squirt out through the vent holes during periods of heavy charging, which will cause corrosion and damage.

## Checking the fusible link



If the headlights or other electrical components do not work and the fuses are O.K., check the fusible link. If the link is melted, it must be replaced.

*Always use a genuine Toyota fusible link for replacement. Never install a wire—even for a temporary fix. It may cause extensive damage and possibly a fire.*

If there is an overload in the circuits from the battery, the fusible link is designed to melt before the entire wiring harness is damaged. *The cause of electrical overload should always be determined before replacing the fusible link.*

## Checking and replacing fuses

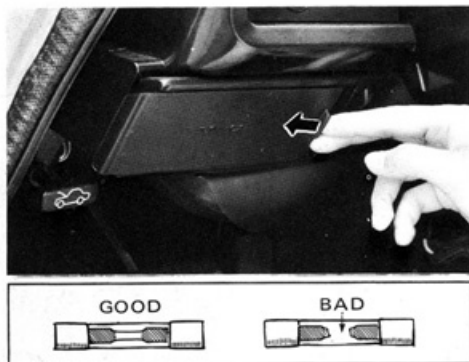

If any light or electrical component doesn't work, check to see whether the fuse has blown.

- Determine which fuse may be causing the problem. The lid of the fuse box shows the name of the circuit for each fuse. (If necessary, page 72 gives the components in each circuit.)
- Look carefully at the fuse. If the thin wire is broken, the fuse has blown. If you're not sure or it's too dark to see, try replacing the suspected fuse with one that you know is good.

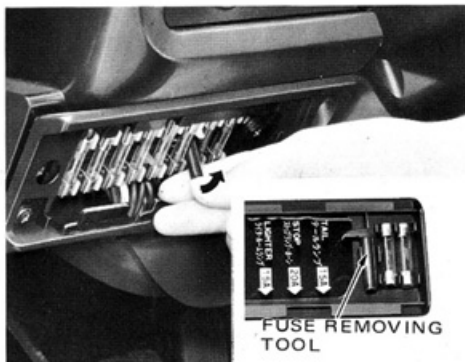

To install a new fuse, turn the ignition switch and the inoperative component **OFF**. Pull the old fuse straight out with the removing tool and push a new one into the clips.

- If you don't have a spare fuse, in an emergency you can pull out the Lighter, Heater or Defog fuse and use it.
- Install the correct fuse.* Never use a higher amperage rating.
- If the new fuse immediately blows out, there is a problem in the electrical system. Have your Toyota dealer correct it as soon as possible.

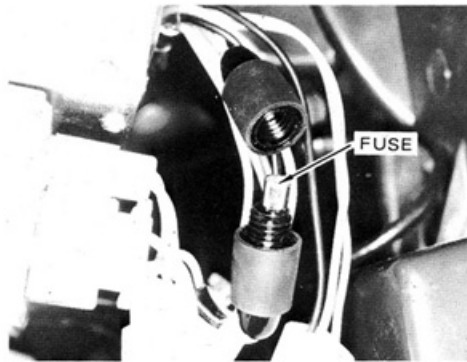

The fuse for the radio and stereo circuit is located behind the upper console.

- If your car is equipped with stereo player, there is a fuse in the radio and stereo circuit.
- 8-track stereo cartridge player: 3-amp. fuse  
Auto-reverse stereo cassette player: 5-amp. fuse

## Checking brake & clutch fluid

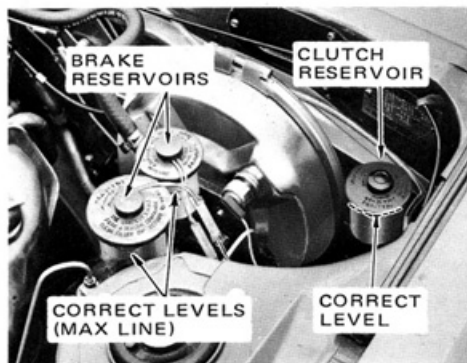

To check the fluid levels, simply look at the see-through reservoirs. The level should be near the MAX line, as shown above.

It is a good habit to check these fluid reservoirs every time you check the engine oil level.

It is normal for the brake reservoir to go down slightly as the front brake pads wear. So be sure to keep the reservoirs filled.

If any reservoir needs frequent refilling, it may indicate a serious mechanical problem.



If the level is low, add brake fluid to the brake or clutch reservoirs.

### PARTS REQUIRED:

1 small can of fresh DOT-3 brake fluid.

**Use caution in filling the reservoirs because brake fluid can harm your eyes and damage painted surfaces.**

Do not use brake fluid that has been opened for more than 1 year or that has had the cap left off. Brake fluid absorbs moisture from the air, and excess moisture can cause a dangerous loss of braking. Also, for this reason you should have the brake fluid drained and replaced periodically. Remove and replace the reservoir covers by hand.

## Checking steering box oil

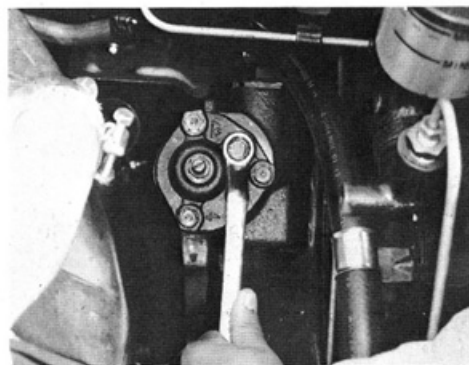

Remove the filler plug and check the oil level—it should be up to the filler hole. If lower, top off with 90-wt. gear oil. Retighten the plug securely.

**PARTS REQUIRED** (If level is low):  
90-wt. "Multipurpose" gear oil (API-GL-4)

### TOOLS REQUIRED:

14-mm wrench.

- Remove the plug by turning it counter-clockwise.
- Make sure the oil is right up to the bottom edge of the filler hole. If needed, top it off with gear oil.
- After installing and retightening the filler plug, visually check the steering box case for leaks, loose parts, or damage.

## Checking automatic transmission fluid

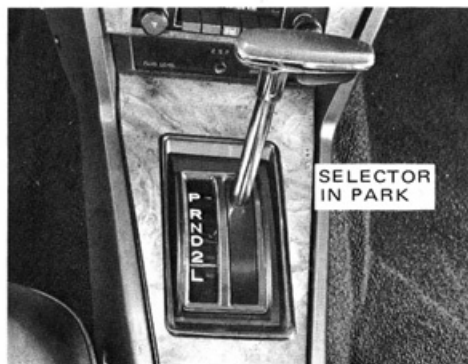

**1. Check the fluid level only when the transmission is either cold or hot (normal operating temperature). With the engine idling, shift into every gear from PARK to LOW and return to PARK.**

**PARTS REQUIRED** (If level is low):  
ATF Type F automatic transmission fluid.

**TOOL REQUIRED:**  
Rag or paper towel.  
Funnel (only for adding fluid).

If the car has not been driven for 8 hours or more, the transmission is "cold." If the car has been driven at least 10 miles, the transmission is "hot." Because the fluid

expands as it warms up, it should be checked only at a "cold" or "hot" condition.



**2. With the engine still idling, check the fluid level and condition on the dipstick. If necessary, add ATF Type F fluid.**

- Pull out the dipstick and wipe it clean.
- Reinsert the dipstick—push it in as far as it will go.
- Pull the dipstick out and look at the fluid level. If the transmission is cold, the level should be in the cold range on the dipstick. Similarly, if it is hot, the fluid level should be in the hot range. If the level is at the low side of either range, add 1 pint of ATF Type F fluid. (Fluid is added through the dipstick tube, using a funnel.)



## Checking manual transmission oil

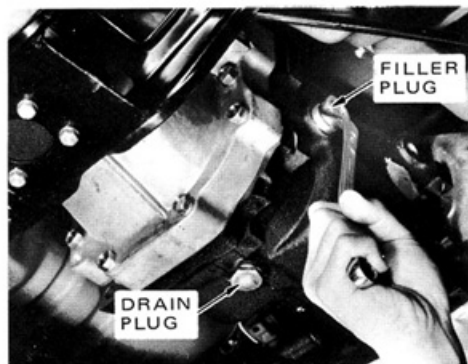

d. While checking the fluid level, also check the condition. If the fluid is black or if it smells burnt, have it changed.

**Remove the filler plug and feel inside the hole with your finger. The oil should come to the bottom edge of the hole. If the level is O.K., reinstall the plug and tighten it.**

**TOOLS REQUIRED:**  
17-mm wrench or adjustable wrench.

- Make sure the car is level while making this check.
- After installing the plug, visually check the transmission case for leaks or damage.

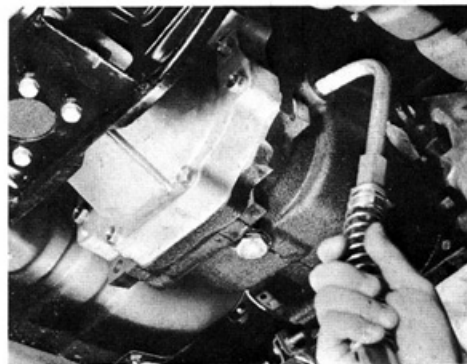

**If the level is low, add 80 or 85-weight\* gear oil until it begins to run out of the filler hole. Reinstall the plug securely.**

**PARTS REQUIRED:**  
80 or 85-weight\* "Multipurpose" gear oil (API-GL-4).

**TOOLS REQUIRED:**  
Lubricant filler.

- Fill the lubricant tool with oil.
- Put the end of the tool into the filler hole and add oil until it begins to run out.
- Install and retighten the filler plug.

\*NOTE: You may use 90-weight gear oil if the outside temperature does not regularly drop below  $-10^{\circ}\text{F}$  ( $-23^{\circ}\text{C}$ ).

## Checking differential oil

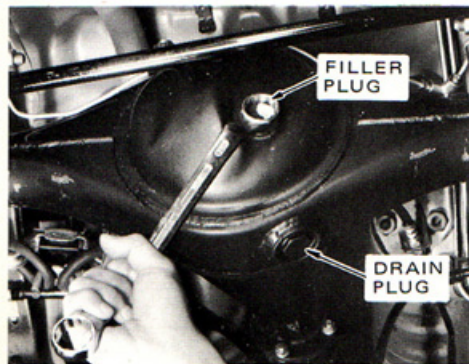

Remove the filler plug and feel inside the hole with your finger. If the oil comes to the bottom edge of the hole, the level is correct. Reinstall the plug.

**TOOLS REQUIRED:**  
24-mm wrench.

- Make sure the car is parked on a level spot.
- After installing the plug, visually check the differential and axle for leaks or damage.

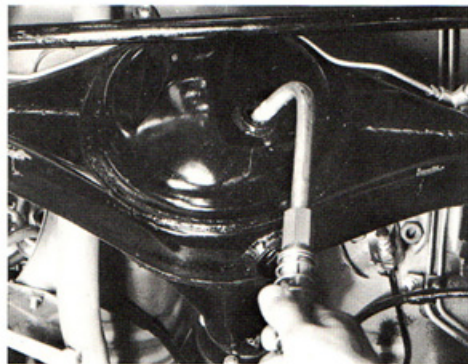

If the level is low, add 90-weight\* hypoid gear oil until it begins to run out of the filler hole. Reinstall the plug.

**PARTS REQUIRED:**  
90-weight\* hypoid gear oil (API-GL-5).

**TOOLS REQUIRED:**  
Lubricant filler.

- Fill the lubricant tool with gear oil.
- Put the end of the tool into the filler hole and add oil until it begins to run out.
- Install and retighten the filler plug.

\*NOTE: If the outside temperatures are regularly below  $-10^{\circ}\text{F}$  ( $-23^{\circ}\text{C}$ ) use 80 or 85 weight gear oil.

## Lubricating the ball joints

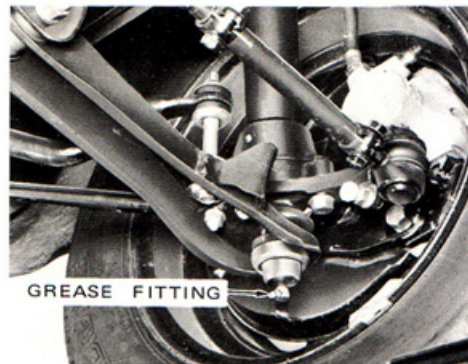

1. Remove the screw plug from the lower ball joint at the right and left side of the front suspension. Temporarily screw on a standard grease fitting.

**TOOLS REQUIRED:**  
10-mm wrench or adjustable wrench.  
Standard grease fitting.  
Grease gun with molybdenum-disulfide lithium chassis lubricant (NLGI No. 1 or 2.)

There is only one ball joint near each front wheel.

Be sure to save the two screw plugs for reinstallation.

## Checking steering wheel freeplay



2. With the grease gun, pump lubricant into each fitting until it begins to flow from the grease outlet in the rubber dust boot. Remove the grease fitting and reinstall the screw plugs.

If the dust boots should be broken, have them replaced by your Toyota dealer.

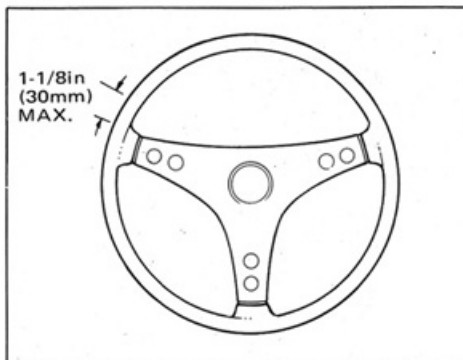

With the car stopped and the front wheels pointed straight ahead, rock the steering wheel gently back and forth. If the freeplay is more than 1-1/8 inch (30 mm), have it adjusted.

Use only a very light finger pressure to rock the wheel slowly.

If the freeplay is excessive, your Toyota dealer can make the necessary adjustment.

## Checking clutch freeplay

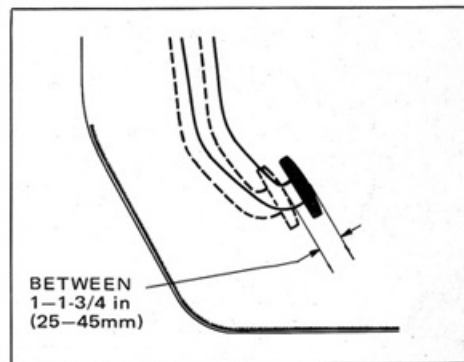

Press down lightly on the clutch pedal and measure the distance it moves freely before the clutch resistance is felt. The freeplay should be between 1 to 1 1/4 inches (25 to 45 mm).

If the freeplay is more or less, have your Toyota dealer adjust the clutch.

## Checking brake pedal clearance

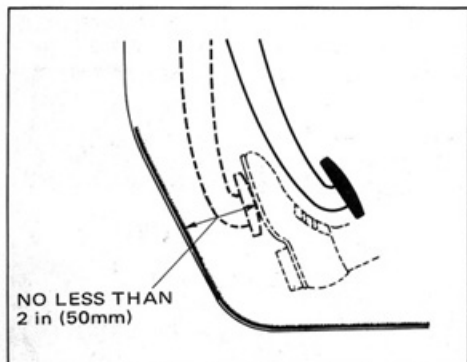

With the engine running, have someone press hard on the brake pedal. The distance from the carpet to the top surface of the pedal should be no less than 2 inches (50 mm).

If the clearance is less, have your Toyota dealer adjust the brakes.

## Checking parking brake adjustment

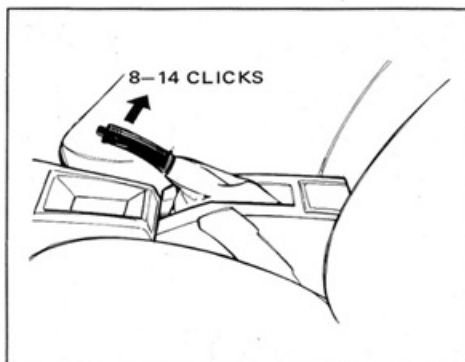

Count the number of clicks as you slowly pull up on the parking brake as far as it will go. The adjustment is correct if you hear 8 to 14 clicks.

If you count more or less clicks, have the parking brake adjusted by your Toyota dealer.

## Checking the brake booster

Sit down in the driver's seat and follow the instructions given below. If your brakes do not operate as described, have them checked at your Toyota dealer.

1. *With the engine stopped, press the brake pedal several times:* the travel distance should not change.
2. *With the brake fully depressed, start the engine:* the pedal should move down a little when the engine starts.
3. *Depress the brake, stop the engine, and hold the pedal in for about 30 seconds:* the pedal should neither sink nor rise.
4. *Restart the engine, run it for about a minute and turn it off. Then firmly depress the brake several times:* the pedal travel should decrease with each application.

## Replacing light bulbs

The illustrations show how to gain access to the bulbs. Replacement bulbs are available at your Toyota dealer. The standard bulb numbers are given below.

No.	Light Bulbs	Bulb No.	Wattage
1	Front turn signal lights	1156	27
2	Front parking lights	67	8
3	Front side marker lights	67	8
4	Rear side marker lights	67	8
5	Back-up lights	1156	27
6	Stop and tail lights	1157	27/8
7	Rear turn signal lights	1156	27
8	License plate lights	89	7.5
9	Interior light*	12V-10CP	10
10	Door courtesy lights*	12V-3CP	5
11	Luggage compartment light* (liftback)	12V-3CP	5

The single-end bulbs are removed by pressing in and turning counterclockwise. The double-end bulbs (\*) pull straight out of the holder clips.

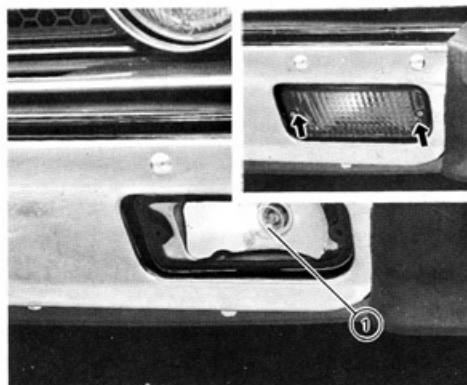

ALL MODELS: Front turn signal lights

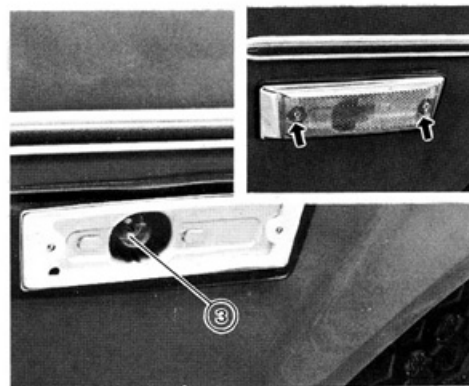

ALL MODELS: Front side marker lights

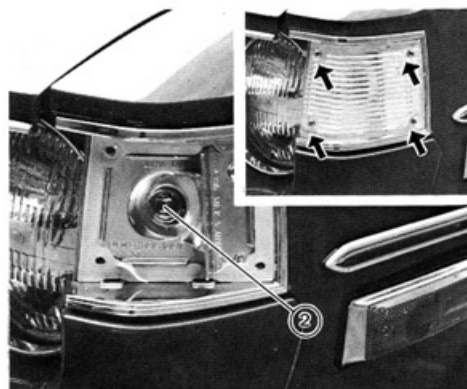

ALL MODELS: Front parking lights

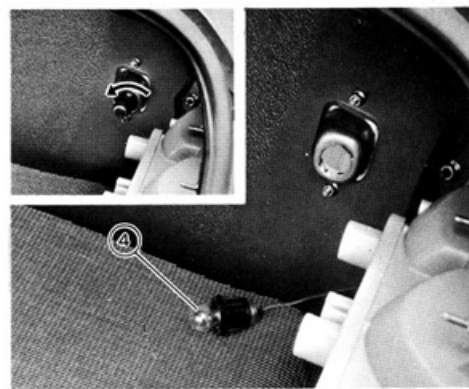

HARDTOP: Rear side marker lights

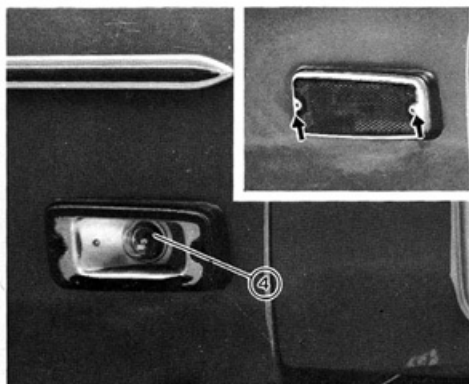

LIFTBACK: Rear side marker lights

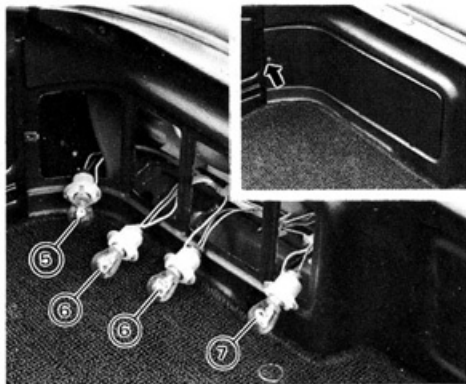

LIFTBACK: Rear turn signal, tail & stop, and back-up lights

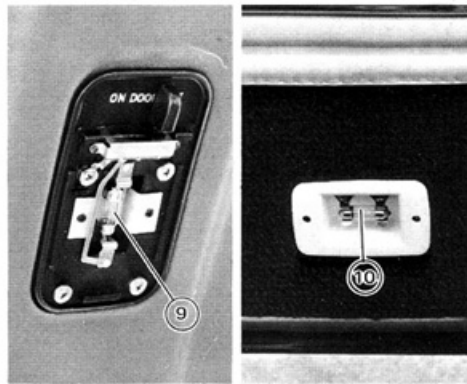

ALL MODELS: Interior and door curtesy lights

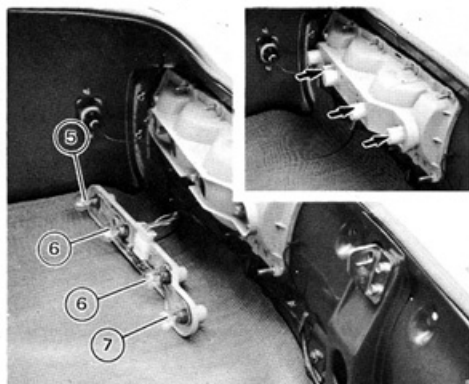

HARDTOP: Rear turn signal, tail & stop, and back-up lights

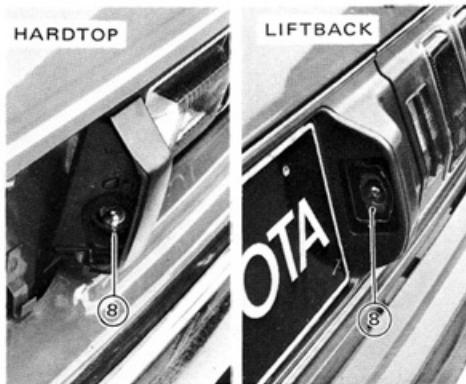

HARDTOP & LIFTBACK: License plate lights

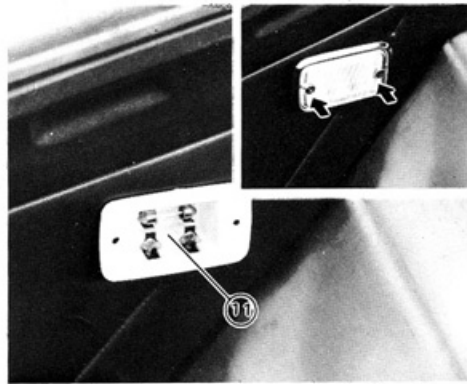

LIFTBACK: Luggage compartment lights

### Your Toyota's identification

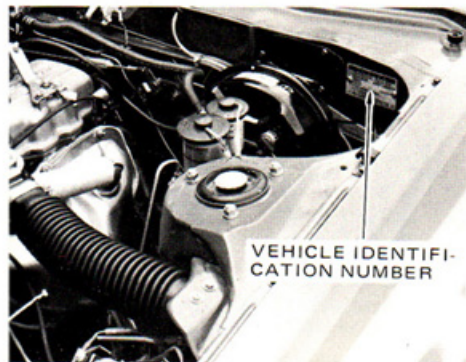

The Vehicle Identification Number (VIN) is on the firewall of the engine compartment and on the top of the instrument panel.

This is the primary identification number for your Toyota. It is used in registering the ownership of your car.

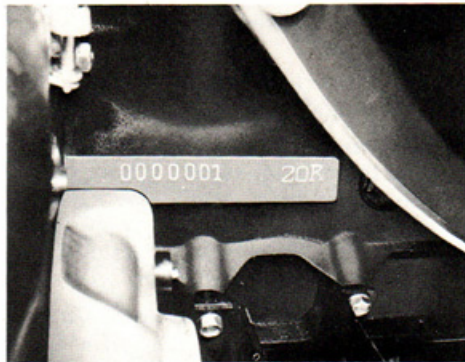

The engine number is stamped on the right side of the engine block.

## Tire information



The recommended cold tire pressure, tire size, and the vehicle capacity weight are given on the placard on the lid of the glove box.

You should check the tire pressures at least once a month. (And don't forget the spare!) Incorrect tire pressure can reduce tire life and make your car less safe to drive.

**Low tire pressure** results in excessive wear, poor handling, reduced fuel economy, and the possibility of blowouts from overheated tires.

**High tire pressure** produces a harsh ride, handling problems, excessive wear at the center of the tire tread, and a greater

possibility of tire damage from road hazards.

These instructions for checking tire pressure should be observed:

- **The pressure should be checked only when the tires are "cold."** If your car has been parked for at least 3 hours and has not been driven for more than 1 mile since, you will get an accurate "cold" tire pressure reading.
- **For sustained high-speeds above 75 mph (120 km/h), add 4 psi (0.3 kg/cm<sup>2</sup>), but never exceed the maximum cold tire pressure molded on the tire sidewall.** Do not drive at sustained high speeds over 75 mph (120 km/h). If the 4 psi (0.3 kg/cm<sup>2</sup>) adjustment will exceed the maximum cold tire pressure.
- **Always use a tire pressure gauge.** The appearance of tire can be misleading. Besides, tire pressures that are even just a few pounds off can degrade handling and ride.
- **Do not "bleed" or reduce tire pressure after driving.** It is normal for the tire pressure to be higher after driving.
- **Never exceed the vehicle capacity weight.** The passenger and luggage weight should be distributed evenly.

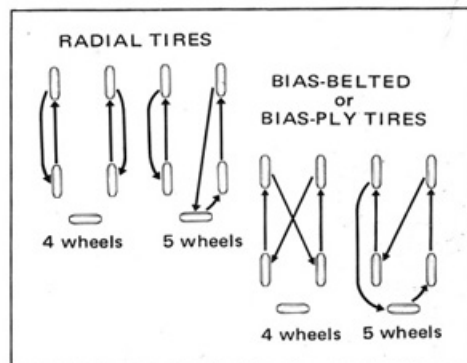

To increase the life of your tires, we recommend rotating them every 6000 miles.

Including the spare tire in your rotation will cause your tires to last longer. However, rotating without the spare means that when replacement time comes, you'll only have to buy three new tires to match the spare, which will be unused. The choice is yours.

When rotating tires, check for uneven wear and damage. Abnormal wear is usually caused by incorrect tire pressure, improper wheel alignment, out-of-balance wheels, or severe braking.



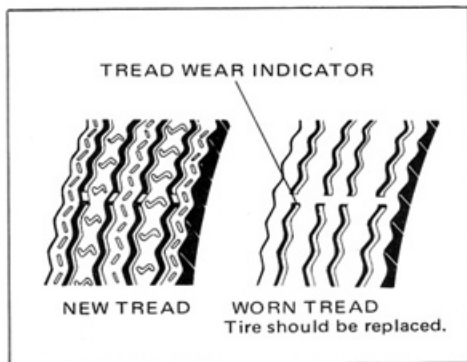

Replace the tires when the tread wear indicators show.

The tires on your Toyota have built-in tread wear indicators to help you know when the tires need replacement. When the tread depth wears to 1/16th of an inch (1.6mm) or less, the indicators show. If you can see the indicators in two or more adjacent grooves, the tire should be replaced.



When replacing a tire, use only the same size and construction as originally installed and with the same or greater load capacity.

Using any other size or type of tire may seriously affect ride, handling, speedometer and odometer calibration, ground clearance, and clearance between the body and tires.

**Do not mix radial, belted, or conventional tires on your car.** It can cause dangerous handling characteristics. If you want to change from conventional tires to radial tires, replace them as a set of four.

If you have tire damage such as cuts, splits, cracks deep enough to expose the fabric, and bulges indicating internal damage, the tire should be replaced.

A tire with questionable damage should be examined by an expert.

If an air loss occurs while driving, do not continue driving with a flat tire. Driving even a short distance can damage a tire beyond repair.

If you have used a aerosol-type sealant for a temporary repair a permanent vulcanized repair should be made as soon as possible. *Do not drive more than 100 miles or over 50 mph (80 km/h) with a temporary repair.*

**If you need snow tires, select the same size and construction as the other tires on your Toyota.**

Snow tires should be inflated to 4 psi (0.3 kg/cm<sup>2</sup>) above the normal cold tire recommendations, but never above the maximum pressure shown on the tire sidewall. *Never drive over 75 mph (120 km/h) with any type of snow tires.*

*If your car has radial tires as original equipment, make sure your snow tires also have radial construction.*

## Tire information (cont.)

Do not use studded tires without first checking local regulations for possible restrictions.

**When replacing wheels for some reason, care should be taken to ensure that the wheels are equivalent to those removed in load capacity, diameter, rim width, and offset.**

Correct replacement wheels are available at your Toyota dealer.

**If you need to replace the tires due to wear or damage, the following precautions should be observed when mounting the tire on the wheel:**

- *Lubricate wheel and tire beads with tire mounting lubricant.*
- *To properly seat the tire on the rim, inflate the tire to a maximum of 40 psi (2.8 kg/cm<sup>2</sup>).*
- *Adjust inflation to the recommended pressure shown on the tire placard.*

## Aluminum Wheel Precautions:

- After driving your car the first 1000 miles (1600km), check to be sure the wheel nuts are tight.
- If you have rotated, repaired, or changed your tires, check to be sure the wheel nuts are still tight after driving 1000 miles (1600km).
- When using tire chains, be careful not to damage the aluminum wheels.
- Use only the Toyota wheel nuts designed for your aluminum wheels.
- When balancing your wheels, use only Toyota balance weights and a plastic or rubber hammer.
- As with any wheel, periodically check your aluminum wheels for damage. If damaged, replace immediately.
- If you are unsure whether you have aluminum wheels, see page 33.

## Consumer information —

This consumer information has been prepared in accordance with regulations issued by the National Highway Traffic Safety Administration of the U.S. Department of Transportation. It provides the purchasers and/or prospective purchasers of Toyota Celicas with information on tire reserve load, acceleration and passing ability, and stopping distance.

Since the results shown here are obtainable by skilled drivers under controlled road and vehicle conditions, the results may differ under other conditions. This data is for your information to improve your judgement while driving. Do not rely on these figures completely, but follow safe driving practices. Remain calm, alert and ready for any maneuver that may be required.

Your Toyota dealer will help answer any questions you may have as you read this information.

## Tire reserve load

These tables list the tire size designations recommended by Toyota for use on the vehicles to which they apply, with the recommended inflation pressure for maximum loading and the tire reserve load percentage for each of the tires listed. The tire reserve load percentage shown is met or exceeded by each vehicle to which the table applies.

**WARNING:** Failure to maintain the recommended tire inflation pressure when operating at maximum loaded vehicle weight, or loading the vehicle beyond the capacities specified on the tire placard on the vehicle, may result in unsafe operating conditions due to premature tire failure, unfavorable handling characteristics, and excessive tire wear. The tire reserve load percentage is a measure of tire capacity, not of vehicle capacity. Loading beyond the specified vehicle capacity may result in failure of other vehicle components.

Models	Manufacturer's Recommended Tire Size	Recommended Cold Inflation Pressure (psi)		Tire Reserve Load* (%)
		Front	Rear	
All models except ST and GT	165SR 14	24	24	12.7
ST model except Liftback ST	175SR 14	24	24	19.7
GT model except Liftback GT	185/70HR 14 185/70SR 14	24	24	19.1
Liftback ST model	175SR 14	24	24	15.9
Liftback GT model	185/70HR 14 185/70SR 14	24	24	15.0

↓  
Your tire size is shown on the tire sidewall. See page 66 for additional information.

The maximum permissible inflation pressure is molded on the tire sidewall, while the recommended inflation pressure is indicated on the placard attached to the glovebox door.

\*The difference, expressed as a percentage of tire load rating, between (a) the load rating of a tire at Toyota's recommended inflation pressure at the maximum loaded vehicle weight and (b) the load imposed upon the tire by the vehicle under those conditions.

## Acceleration and passing ability

The following figures indicate passing times and distances that can be met or exceeded by the vehicle to which they apply, in the situations diagrammed.

A low speed pass assumes an initial speed of 20 mph and a limiting speed of 35 mph. A high speed pass assumes an initial speed of 50 mph and a limiting speed of 80 mph.

NOTICE: The information presented represents results obtainable by skilled drivers under controlled road and vehicle conditions, and the information may not be correct under other conditions.

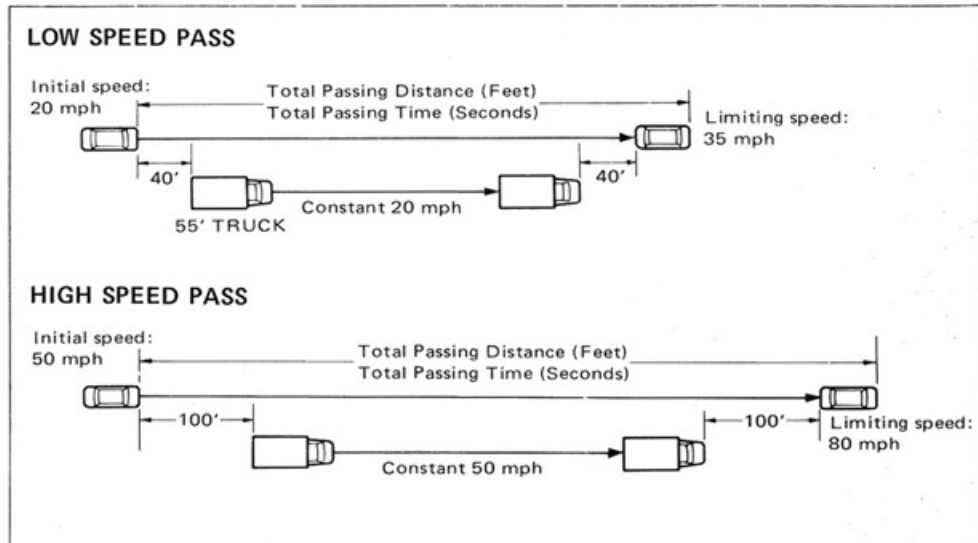

Models (Transmission)	ALL MODELS (EXCEPT CALIF. AND HI-ALT.)				CALIF. AND HI-ALT.			
	Low speed pass		High speed pass		Low speed pass		High speed pass	
	Feet	Seconds	Feet	Seconds	Feet	Seconds	Feet	Seconds
Manual	400	8.5	1330	14.4	402	8.6	1336	14.6
Automatic	400	8.5	1337	14.6	415	9.0	1350	14.8
Manual with air conditioning	403	8.6	1337	14.6	410	8.9	1345	14.8
Automatic with air conditioning	405	8.7	1344	14.8	420	9.1	1362	15.0

## Stopping distance

These figures indicate braking performance that can be met or exceeded by the vehicle to which they apply, without locking the wheels, under different conditions of loading and with partial failures of the braking system.

NOTICE: The information presented represents results obtainable by skilled drivers under controlled road and vehicle conditions, and the information may not be correct under other conditions.

Condition	Stopping distance in feet from 60 mph	
	All models except GT	All GT models
Fully operational service brake – Light load	177 ft	160 ft
Fully operational service brake – Maximum load	185 ft	168 ft
Emergency service brakes (with partial service brake system failure).	440 ft	440 ft
Brake power unit failure	230 ft	230 ft
	0 100 200 300 400	0 100 200 300 400



# specifications—section 8

## Dimensions and weights

		Hardtop	Liftback
Overall length	in	174.6	174.2
	mm	4435	4425
Overall width	in	63.8	63.8
	mm	1620	1620
Overall height	in	52.0	51.0
	mm	1320	1295
Ground clearance	in	6.7	6.7
	mm	170	170
Wheelbase	in	98.2	98.2
	mm	2495	2495
Front track	in	52.6	53.1
	mm	1335	1350
	in	53.1* <sup>1</sup>	
	mm	1350	
Rear track	in	51.0	51.6
	mm	1295	1310
	in	51.6* <sup>1</sup>	
	mm	1310	
Turning circle	ft	33.0	33.0
	m	10.0	10.0
Curb weight	lb	2560* <sup>2</sup>	2610* <sup>2</sup>
	kg	1164	1186
Gross vehicle weight	lb	3285* <sup>2</sup>	3335* <sup>2</sup>
	kg	1493	1516
Vehicle capacity weight* <sup>3</sup>	lb	725	725
	kg	330	330

NOTE: \*<sup>1</sup> — ST and GT models  
 \*<sup>2</sup> — based on GT model with 5 speed transmission  
 \*<sup>3</sup> — includes both occupants and luggage

## Engine

Model	20R
Type	4 cylinder in-line, 4 cycle
Valves	Overhead, crossflow arrangement
Bore and stroke	3.48 x 3.50 inches (88.5 x 89.0 mm)
Displacement	133.6 cu.in. (2189 cc)
Compression ratio	8.4 to 1
Maximum horsepower	95 HP/4800 rpm
SAE net	(90 HP/4800 rpm—Calif. and Hi-alt.)
Maximum torque	122 ft-lb/2400 rpm
SAE net	(16.8 m-kp/2400 rpm)

## Gasoline

Fuel required	90 octane RON (Research Octane No.)
U.S.A.	Unleaded fuel <b>REQUIRED</b>
Canada	Unleaded fuel recommended, but any regular gasoline is permissible if it is not available
Fuel tank capacity	15.3 gal (12.8 Imp. gal, 58 liters)

## Service specifications

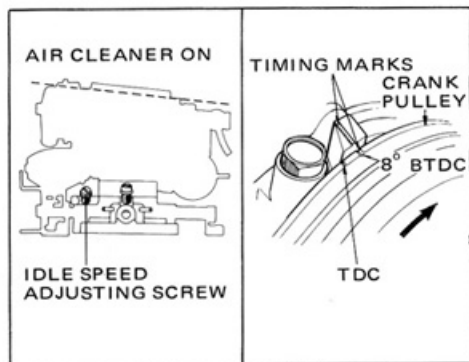

### TUNE-UP

Firing order: 1-3-4-2

Distributor point rubbing block gap:  
.018 in (.45 mm)

Dwell angle: 52 deg

Idle speed (trans. in neutral):

Manual trans.: 800 rpm

Automatic trans.: 850 rpm

Ignition timing:

Hi-alt.: 8° BTDC/700 – 900 rpm  
13° BTDC (over 4000 ft).

Others:

Manual trans. 8° BTDC/800 rpm  
Automatic trans. 8° BTDC/850 rpm

Recommended spark plugs:

Nippondenso W16EP or W16EX-U  
NGK BP5ES-L or BP5EA-L

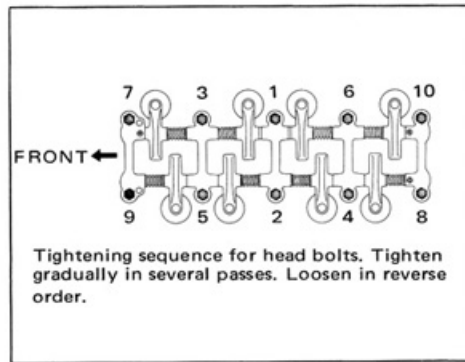

Spark plug gap: .031 in (.8 mm)

Spark plug torque:  
11 – 15 ft-lb (1.5 – 2.1 m-kp)

### ENGINE

Tightening torques, ft-lb (m-kp):

Head bolts: 52 – 63 (7.2 – 8.8)

Intake manifold bolts:  
11 – 15 (1.5 – 2.1)

Exhaust manifold bolts:

29 – 36 (4.0 – 5.0)

Valve cover bolts: 8 – 11 (1.0 – 1.6)

Oil pan drain plug: 26 – 32 (3.5 – 4.5)

Valve clearance (engine hot), in (mm):

Intake: .008 (.20)

Exhaust: .012 (.30)

Compression pressure at 250 rpm,  
psi (kg/cm<sup>2</sup>)

Normal: 156 (11.0)

Minimum allowable: 128 (9.0)

Manifold vacuum at idle:

More than 16.5 inHg (420 mmHg)

Drive belt deflection with 22 lb (10 kg)  
thumb pressure, in (mm):

Fan x alternator: 1/3 – 1/2 (8 – 13)

Air pump x crankshaft:

1/3 – 1/2 (8 – 13)

A/C compressor x crankshaft:

7/16 – 1/2 (11 – 13)

### ENGINE LUBRICATION

Engine oil capacity:

Dry refill: with filter 5.3 qts.  
(4.4 Imp. qts., 5.0 liters)

Drain and refill:

with filter: 4.5 qts.

(3.8 Imp.qts., 4.3 liters)

without filter: 3.9 qts.

(3.3 Imp.qts., 3.7 liters)

(With the engine running, check for oil leaks. Stop the engine and wait a few minutes. Then double-check the oil level on the dipstick).



### Recommended viscosity:

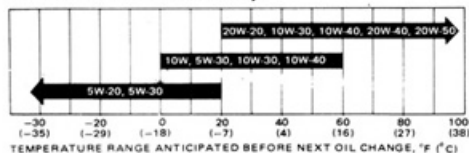

Type: Grade SE or better

### COOLING SYSTEM

#### Total capacity:

8.5 qt. (7.0 Imp. qt, 8.0 liters)

Type: Ethylene-glycol coolant  
(Do not use alcohol type)

Radiator cap pressure: 12.8 psi (.9 kg/cm<sup>2</sup>)

### BATTERY

#### Minimum voltage:

9.6 volts at current load of 150 amps

#### Specific gravity readings at 68°F (20°C):

1.260 Fully charged  
1.160 Half charged  
1.060 Discharged

#### Charging rates:

Quick charge: 80 – 90% of capacity  
Slow charge: 10% of capacity

### ALTERNATOR/REGULATOR

Voltage under load: 13.8 – 14.8 volts

Load current with headlights and all accessories on: 30+ amps at 2000 rpm

### STARTER

Minimum cranking voltage: 9.6 volts

### CLUTCH

Pedal freeplay: 1 – 1½ (25 – 45 mm)

Clutch fluid: DOT 3

### MANUAL TRANSMISSION

#### Lubricant capacity:

4-speed 2.9 qt. (2.5 Imp. qt, 2.8 liters)  
5-speed 2.8 qt. (2.4 Imp. qt, 2.7 liters)

#### Lubricant viscosity: SAE 80W or 85W

You may use SAE 90 if the outside temperature does not regularly drop below -10°F (-23°C).

Type: Multipurpose API-GL-4

#### Drain/filler plug torque:

27 – 32 ft-lb (3.7 – 4.5 m-kg)

### AUTOMATIC TRANSMISSION

#### Fluid capacity:

Drain and refill:  
2.5 qt. (2.1 Imp. qt, 2.4 liters)  
Dry refill: 6.7 qt. (5.5 Imp. qt, 6.3 liters)

Type: ATF type F

#### Tightening torques:

Oil pan bolts:  
2.8 – 3.6 ft-lb (.4 – .5 m-kg)  
Oil screen bolts:  
3.6 – 4.3 ft-lb (.5 – .6 m-kg)  
Drain plug:  
11 – 16 ft-lb (1.5 – 2.0 m-kg)

### DIFFERENTIAL

#### Lubricant capacity:

1.4 qt. (1.1 Imp. qt, 1.3 liters)

#### Viscosity:

Above -10°F (-23°C) SAE 90  
Below -10°F (-23°C) SAE 80W or 85W

Type: Multipurpose API-GL-5  
(hypoid gear oil)

#### Tightening torques:

Filler plug:  
27 – 31 ft-lb (3.7 – 4.3 m-kg)  
Drain plug:  
29 – 43 ft-lb (4.0 – 6.0 m-kg)

## STEERING

**Wheel freeplay:** Less than 1-1/8 in (30 mm)

**Lubricant viscosity:** SAE 90

**Type:** Multipurpose API-GL-4

## CHASSIS

**Ball joint grease:** Molybdenum-disulphide lithium base, NLGI No. 1 or 2  
(Do not use multipurpose or chassis grease)

**Wheel bearing grease:** Multipurpose NLGI No. 2

**Front suspension upper support bearing grease:**  
Multipurpose NLGI No. 2

**Front axle lock nut torque:**  
22 ft-lb (3.0 m-kg)  
While spining wheel, torque to above.  
Back off nut retighten just enough so that there is no end play in bearing.

## BRAKES

**Minimum pedal height:** 2 in (50 mm)

**Front pad wear limit:** .04 in (1.0 mm)

**Rear lining wear limit:** .04 in (1.0 mm)

**Brake fluid:** DOT 3

**Parking brake adjustment:** 8 – 14 clicks

## FRONT-END ALIGNMENT

**Toe-in:** 1 mm  
**Camber:**  $1^{\circ}\pm 30'$   
**Caster:**  $1^{\circ}45'\pm 30'$   
**Axis inclination:**  $7^{\circ}30'\pm 30'$

## TIRES AND WHEELS

**Tire size:** GT 185/70HR 14  
185/70SR 14  
ST 175SR 14  
Others 165SR 14

**Tire pressure, psi (kg/cm<sup>2</sup>)**

	Front	Rear
All models	24 (1.7)	24 (1.7)

Sustained high speeds above 75 mph (120 km/h), add 4 psi (0.3 kg/cm<sup>2</sup>)

**Wheel size:**  
All STs & GTs 5½-J x 14  
Others 5-J x 14

**Wheel nut torque:**  
65 – 86 ft-lb (9 – 12 m-kg)

## FUSES

**TAIL (15 amp):** Front parking lights, Front & rear side marker lights, Tail lights, License plate lights, Glove box light, and Instrument panel lights

**STOP (20 amp):** Stop lights, Hazard warning lights, Horn, and Key reminder buzzer

**LIGHTER (15 amp):** Cigarette lighter, Clock, Interior light, Door courtesy lights, and Luggage compartment light

**HEATER (20 amp):** Heater (Air cond.) blower motor, Seat belt warning light & buzzer, Back-up lights, Meter, and Gauges

**DEFOG (20 amp):** Rear window defogger

**TURN (15 amp):** Turn signal lights, Windshield wiper and washer

**ENGINE (15 amp):** Main relay, and Regulator IG terminal

**RADIO (5 amp):** Radio and Tape player

**NOTE 1:** Headlight circuit is protected by the fusible link.

**NOTE 2:** There is also a fuse in the radio and stereo circuit. This fuse is located behind the upper console. (See page 56.)

# index - section 9

## A

Adjustment	
Engine drive belts	52
Seat belts	6
Seats	4
Spark plug gap	54
Air cleaner	53
Air conditioner	17
Air pump caution	52
Antifreeze	51
Anti-theft steering column lock	9
Appearance care	
Cleaning the interior	38
Washing and waxing	37
Ashtray	8
Automatic transmission	
Fluid level	58
Park locking mechanism	25
Pretrip safety check	26
Selector lever	25
Specifications	75
Axle, Rear (See Differential)	

## B

Ball joint lubrication	60
Battery	
Discharge warning light	13
Emergency starting	30
Fluid level	55
Specifications	75

Winter driving tips	28
Belts	
Engine drive	52
Seat	6
Blown fuse	56
Boost ventilator	18
Brakes	
Booster	62
Fluid caution	57
Fluid level	57
Fluid recommendation	57, 76
Parking	21
Parking brake adjustment	62
Pedal travel	62
Warning light	12
Break-in tips	2
Buckle, Seat belt	6
Bulbs	
Replacement	63
Specifications	63
Buzzer	
Key reminder	9
Seat belt warning	13

## C

Cap, Filler	
Engine oil	48
Fuel	21
Radiator	50
Capacity	
Automatic transmission	75

Differential	75
Engine coolant	75
Engine oil	74
Fuel tank	2, 73
Manual transmission	75
Carbon monoxide caution	22
Carpet care	38
Charging system indicator	13
Changing wheels and tires	32
Catalytic converter	1
Cigarette lighter	8
Cleaning	37
Clutch	
Fluid level	57
Pedal freeplay	61
Cold weather operation	28
Cold weather starting	23
Consumer information	65, 68
Cooling (See Air conditioner)	
Cooling system	
Coolant recommendation	51, 75
Overheating	31
Radiator and reservoir	50
Winter driving tips	28
Cover, luggage	5

## D

Day-night rear view mirror	20
Defogger, rear window	12
Defogging (See Heater)	
Defrosting (See Heater)	

Differential	
Oil level	60
Specifications	75
Dimensions and weights	73
Dimmer switch, Headlights	10
Directional signal	10
Dipstick	
Automatic transmission fluid	58
Engine oil	48
Do-it-yourself maintenance	47
Door locks	
Caution in winter	28
Locking caution	3, 4
Operation	3, 4
Drive belts, Engine	52
Driving	
Automatic transmission	25
Break-in tips	2
Driving tips	23
Economical driving	26
Good driving practice	24, 25
Manual transmission	24
Pretrip safety check	26
Winter driving tips	28
Discharge warning light	13

## E

Electrical	
Battery	55
Discharge warning light	13
Fuses	56

Fusible link	55
Light bulbs	63
Specifications	75, 76
Electro sensor panel	15
Emergency, In case of	
Car won't start	29
Emergency flasher switch	11
Flat tire	32
Jump starting	30
Lose your key	31
Overheats	31
Push starting	29
Towing	36

## Engine

Cooling system (See engine coolant)	
Exhaust gas caution	22
High exhaust temperature warning	12
Hood release	22
Low oil pressure warning light	13
Overheats	31
Serial number	65
Specifications	73, 74
Starting technique	23
Temperature gauge	14

## Engine coolant

Antifreeze	51
Capacity	7
Changing	51
Checking level	50
Recommendation	51, 75
Winter driving tips	28
Engine drive belts	52

## Engine oil

Capacity	74
Changing	49
Checking level	48
Dipstick	48
Filter	49
Low oil pressure warning light	13
Recommendation	48, 75
Viscosity recommendation	48, 75
Winter driving tips	28
ESP warning light	13
Exhaust gas caution	22
Exhaust temperature warning light	12
Explanation of maintenance items	42

## F

### Filler cap

Engine oil	48
Fuel	21
Radiator	50
Filter, Oil	49
Flat tire	32
Flooded engine	23
Fluid levels	
Automatic transmission	58
Battery	55
Brake and clutch	57
Differential	60
Engine coolant	50
Engine oil	48
Manual transmission	59

Steering gear box	57
Fluid recommendation	74, 75, 76
Folding rear seat (liftback)	5
Foreign countries, Operation in	2
Four way hazard flasher	11
Freeplay	
*Clutch pedal	61
Steering wheel	61
Front end alignment	76
Fuel	
Capacity	2, 73
Economy	26
Gauge	14
Recommendation	1, 73
Tank cap	21
Fuses	
Checking and replacing	56
In-line fuse	56
Specifications	76
Fusible link	55

## G

Gasoline (See Fuel)	
Gasoline tank capacity	2, 73
Gauge	
Engine temperature	14
Fuel	14
Glove box	20
Grease fittings	60

## H

Hazard warning flasher	11
Headlight	
Dimmer switch	10
Switch	10
Heater operation	16
High exhaust temperature warning light	12
High speed operation	
During break-in	2
Tires	66
Hood release	22
Hood stay	22
Horn	27

## I

Identification numbers	
Engine	65
Vehicle	65
Ignition switch	9
In case of emergency	29
Indicator lights	
Brake	12
Discharge	13
ESP	13
High exhaust temperature	12
Low oil pressure	13
Seat belt	13
Inflation pressure, Tire	66
Instrument panel	8
Instrument panel light control	11

## J

Jack	
Operation	32
Storage	32
Jump starting	30

## K

Keys	3
Lose your key	31
Reminder warning buzzer	9

## L

Lap and shoulder belts	6, 7
Lighter, Cigarette	8
Lights	
Back-up	63
Brake system warning	12
Courtesy	63
Discharge warning	13
Electro sensor panel warning	15
Emergency warning	11
High exhaust temperature warning	12
Interior	63
License plate	63
Low oil pressure warning	13
Parking brake warning	12
Seat belt warning	13
Side marker	63

Stop and tail	63
Turn signal	63
Lock	
Doors	3, 4
Steering column	9
Low oil pressure warning light	13
Luggage cover	5

## M

Maintenance	
Does your car need a repair?	45
Do-it-yourself	47
Explanation of maintenance items	42
Maintenance requirements	39
Schedule	40
Where to go for service	39
Your responsibility for maintenance	22
Manual transmission	
Checking oil level	59
Driving	24
Gear shift lever	24
Oil recommendation	75
Specification	75
Maximum allowable speeds	
Automatic transmission	25
Manual transmission	24
Mirror	
Day-night rear view mirror	20
Outside rear view mirror	21

## N

New car break-in	2
------------------	---

## O

Octane rating, Fuel	2, 73
Oil	
Automatic transmission	58
Differential	60
Engine	48
Manual transmission	59
Steering gear box	57
Recommendation	74, 75, 76
Viscosity recommendation	75
Operation in foreign countries	2
Outside rear view mirror	21
Overheats, Engine	31
Overseas operation	2
Overview	
Engine compartment	47
Instruments and controls	8

## P

Panel light control, Instrument	11
Parking brake	21
Adjustment	62
Emergency stop	21
Warning light	12
Polishing	37

Pressure, Tire inflation	66
Pretrip safety check	26

## R

Radiator	
Cap	50
Coolant	51
Overheats	31
Pretrip safety check	27
Radio	18
Rear axle (See Differential)	
Rear seat entry	5
Rear seat, Folding (liftback)	5
Rear view mirror	20, 21
Rear window defogger	12
Registration, Vehicle	
Engine serial number	65
Vehicle identification number	65
Release, Hood	22
Retractor, Seat belt	6, 7
Rotation, Tire	66

## S

Safety check, Pretrip	26
Seats	4
Seat belts	
Cleaning	7
Fastening	6, 7
Inspection	7

Replacement	7
Retractor	6, 7
Seat belt tips	7
Warning light and buzzer	13
Shifting speed, Transmission	24, 25
Shift pattern, Transmission	24, 25
Signal, Turn	10
Snow tires	67
Spare tire	32
Spark plug	
Deposit	54
Gap adjustment	54
Replacement	53
Winter driving tips	28
Specifications	
Alternator/Regulator	75
Automatic transmission	75
Battery	75
Brakes	76
Chassis	76
Clutch	75
Cooling system	75
Differential	75
Dimensions and weights	73
Engine	73, 74
Front end alignment	76
Fuses	76
Gasoline	73
Light bulbs	63
Manual transmission	75
Starter	75
Steering	75
Tires and wheels	76

Tune up	74
Starting the engine	
Emergency	29
Normal procedure	23
Stay, hood	22
Stereo tape player	19
Steering	
Column lock	9
Gear box oil	57
Wheel freeplay	61

## T

Tachometer	14
Tape player, Stereo	19
Temperature gauge, Engine	14
Tire	
Changing	32
Damage	67
Flat tire	32
High speed operation	66
Inflation pressure	66
Repair	68
Replacement	67
Rotation	66
Snow tires	67
Spare tires	32
Tire information	66
Tread wear indicator	67
Towing	36
Transmission	
Automatic (See Automatic transmission)	

Manual (See Manual transmission)	
Tread wear indicator, Tire	67
Turn signal	
Lights	63
Switch	10

## V

Vehicle identification number	65
Ventilation (See Heater)	
Ventilator, Boost	18
Viscosity, Oil	74, 75

## W

Warning buzzer, Seat belt	13
Warning lights	
Brake system	12
Discharge	13
Electro sensor panel	13
Emergency	11
High exhaust temperature	12
Low oil pressure	13
Seat belt	13
Warranty (See Warranty booklet)	
Washer switch, Windshield	11
Washing	37
Waxing	37
Weights and dimensions	73
Wheel	
Changing	32

Replacement . . . . .	68
Windshield	
Defogging or defrosting (See Heater)	
Wiper and washer switch . . . . .	11
Winter driving tips . . . . .	28
Wiper switch, Windshield . . . . .	11









## Gas station information

**Gasoline: 90 octane or higher** (Research Octane No.)

- **U.S.A. - Use only UNLEADED fuel.**
- **Canada - UNLEADED fuel is recommended. Using unleaded fuel will prolong engine and spark plug life.** If unleaded fuel is not available, you may use any regular gasoline.

### Fuel tank capacity:

All models 15.3 gal (12.8 Imp. gal, 58 litres)

**Hoode release:** Pull handle under left side of dash.

**Tire pressure:** See label on driver's door edge.

**Tire information:** See page 66, 67 and 68.

### Recommended oil: API grade "SE"

Use SAE 20-40 or 20-50 weight if normal temperatures are above 10°F (12°C). For other viscosity recommendations, see page 70.

**Automatic transmission fluid:** With engine idling, shift through all gears and return to P. Then check level of fluid on dipstick. Use ATP type fluid.

## Quick index

- |   |    |   |    |
|---|----|---|----|
| • If your car won't start . . . . .       | 29 | • Starting tips for hot or cold weather . . .   | 23 |
| • If you have a flat tire . . . . .       | 32 | • Driving tips for the first 1000 miles . . . . | 2  |
| • If a warning light comes on . . . . .   | 12 | • Pretrip safety check . . . . .                | 26 |
| • If your car overheats . . . . .         | 31 | • The maintenance schedule . . . . .            | 40 |
| • If your car needs to be towed . . . . . | 36 | • Complete index . . . . .                      | 77 |